

## Cloud Link 4G Modem User Manual

FD-585 | 1.0 | 2016

Honeywell Process Solutions

Mercury Instruments 512 Virginia Drive. Ft. Washington, PA 19034 USA

Copyright 2016 . Honeywell Process Solutions. All rights reserved.

Information in this document is subject to change without notice. The software described in this document is furnished under a license agreement or non-disclosure agreement. The software may be used or copied only in accordance with the terms of those agreements. No part of this publication may be reproduced, stored in a retrieval system, or transmitted in any form or any means electronic or mechanical, including photocopying and recording for any purpose other than the purchaser's personal use without the written permission of Honeywell Process Solutions.

Mercury Instruments 512 Virginia Drive. Ft. Washington, PA 19034 USA

# CONTENTS

<b>1 General</b> .....	<b>5</b>
1.1 Cloud Link 4G Modem Overview .....	6
1.2 Cloud Link 4G Modem Feature Summary .....	6
<b>2 Safety</b> .....	<b>7</b>
2.1 Accordance to regulations .....	8
2.2 Label .....	9
<b>3 Mechanical Assembly</b> .....	<b>11</b>
3.1 Device Dimensions .....	12
3.2 Power options .....	14
3.3 Antenna Options .....	15
3.4 Installation Drawing .....	17
3.5 Field Installation .....	18
<b>4 Electrical Assembly</b> .....	<b>19</b>
4.1 Power Supply options .....	20
4.1.1 Power Port - Battery .....	21
4.1.1.1 Battery pack drawing .....	22
4.1.2 Power Port – External Supply .....	23
4.2 Serial Communication – RS232/485 .....	24
4.3 Pulse Counter .....	27
4.4 Antenna Interface .....	28
4.5 Magnetic REED Switch .....	29
4.6 SIM Card .....	30
4.7 BLE (Bluetooth Low Energy) .....	33
4.8 LED Indicators .....	34
<b>5 Configuring Cloud Link 4G Modem</b> .....	<b>37</b>
5.1 Working Modes .....	38
5.2 Getting started with MasterLink iOS application .....	39
5.2.1 Login and Registration .....	39
5.2.2 Adding a New Site .....	40
5.2.3 Connecting to Existing Site .....	41
5.3 Bluetooth Pairing with MasterLink iOS application .....	43
5.3.1 Pairing with Just Works (without passkey) .....	43
5.3.2 Pairing with Passkey Entry .....	44
5.4 Item Reference .....	46
5.5 Device Configuration Over Bluetooth .....	54
5.5.1 Configuration by Group .....	54
5.5.2 Configuration by Item .....	55

# CONTENTS

5.6	Firmware Upgrade .....	56
5.7	Server Mode .....	58
5.8	Pulse Counting .....	59
5.9	Changing the Battery .....	60
5.10	Factory Reset .....	61
5.11	Time Sync .....	62
5.12	Secure Sign On .....	63
5.12.1	Secure Sign On Over Bluetooth .....	64
5.12.2	White List .....	65
5.13	Logs .....	66
5.13.1	Event Logs .....	66
5.13.2	Diagnostic Logs .....	68
5.13.3	Alarm Logs .....	69
5.13.4	Cellular Logs .....	71

# CHAPTER 1

## 1 General

This chapter introduces the Cloud Link 4G Modem and also talks about the device features.

## 1.1 Cloud Link 4G Modem Overview

Cloud Link 4G Modem is a cellular radio that can be used as a component in Electronic Volume Correctors platforms and in wireless platforms. Cloud Link 4G Modem can function as a standalone transparent modem, and can also be included as a component in EC 350 and MiWireless. Cloud Link 4G Modem can also interface with MasterLink.

## 1.2 Cloud Link 4G Modem Feature Summary

- RS-232 & RS-485
- Bluetooth Low Energy V4.0
- GSM / GPRS (2G)UMTS / HSPA (3G) LTE (4G)
- IPv4
- Secure Socket Layer (SSL / TLS 1.2)
- Client Mode
- Server Mode
- Cellular Statistics
- Over-the-Air Firmware Configuration Updates
- North American Cellular Network Approvals
- Alarm-Sensing or Pulse-Counting Input
- Built-In magnetic call switch
- External power supply (30V max)
- Diversity Antenna Connection
- Single or Dual 3.6V battery operation
- Transparent Modem

# CHAPTER 2

## 2 Safety

This chapter describes the different safety aspects involved with the Cloud Link 4G Modem, along with the agency approvals.

## 2.1 Accordance to regulations

- CSA C/US Class I, Division 2, Group A, B, C & D; T4
- IEC 61000-6-2
- IEC 61000-6-4
- CAN/CSA-C22.2 No. 0-M91 General Requirements – Canadian Electrical Code, Part II
- C22.2 No. 142-M1987 Process Control Equipment
- C22.2 No. 213-15 Non-Incendive Electrical Equipment for Use in Class I, Division 2 Hazardous Locations
- FCC Title 47 CFR sub-part B
- IC Canada (ICES-003 Issue 6)
- PTCRB (55982)
- List of USA and Canada Carriers certification in Progress: Verizon, AT&T, T-Mobile, Rogers, Bell Mobility
- Bluetooth 4.0 (Declaration ID: D031443)
- Supporting 3GPP Release 9 LTE, E-UTRA operating bands 2, 4, 5, 13 and 17
- ROHS compliant

**Operating Temp:** -25 °C to +65 °C

### Compliance with FCC and IC Rules and Regulations

- The integration is limited to fixed or mobile categorized host devices, where a separation distance between the antenna and any person of min. 20cm can be assured during normal operating conditions.
- For mobile and fixed operation configurations the antenna gain, including cable loss, must not exceed the limits 1.10 dBd (850 MHz), 5.50 dBi (AWS) and 2.51 dBi (1900 MHz).

### Verizon FOTA support:

Cloud Link 4G Modem does not support FOTA upgrade for the cellular module (Gemalto's PLS8-X).



## Conditions for safe use

- The Cloud Link 4G Modem is available with battery pack 51203165-100 which is comprised of a single cell and a Y connector. A second battery pack (same model) may be connected to this connector to create a 2 cell parallel pack. If a second pack is to be added to an existing pack, the user shall ensure that both packs are new and unused. The single battery pack or the assembly of two battery packs shall only be replaced in a non-hazardous area. The connection of more than 2 battery packs may pose a serious hazard.
- None of the battery packs shall be recharged under any circumstances.
- The battery packs shall not be replaced in a hazardous area.
- The Cloud Link 4G Modem battery packs shall be housed within an enclosure providing a minimum ingress protection level of IP 20.
- The SIM card connection shall only be used with SIM cards. The SIM card may be connected or disconnected only in a non-hazardous area or when the device has been de-energized.
- All connections into the Cloud Link 4G Modem shall be sourced from Class 2 circuits.
- This device shall be installed in a suitable end use enclosure providing a degree of protection acceptable to the local authority having jurisdiction.
- Non-Incendive when Installed As Per Drawing 40-6114

## 2.2 Label

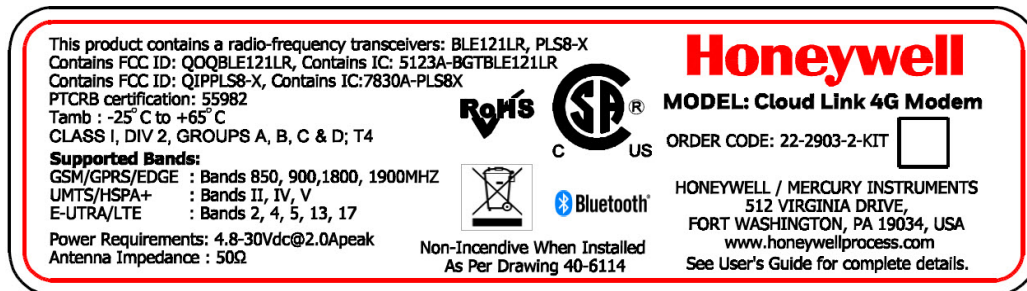

Figure 2.1 - Cloud Link 4G Modem Label

This page intentionally left blank to ensure new chapters start on right (odd number) pages.

# CHAPTER 3

## 3 Mechanical Assembly

This chapter describes the mechanical assembly of the different components of a Cloud Link 4G Modem.

### 3.1 Device Dimensions

The figure below illustrates the dimensions of a Cloud Link 4G Modem device. (All dimensions are in mm)

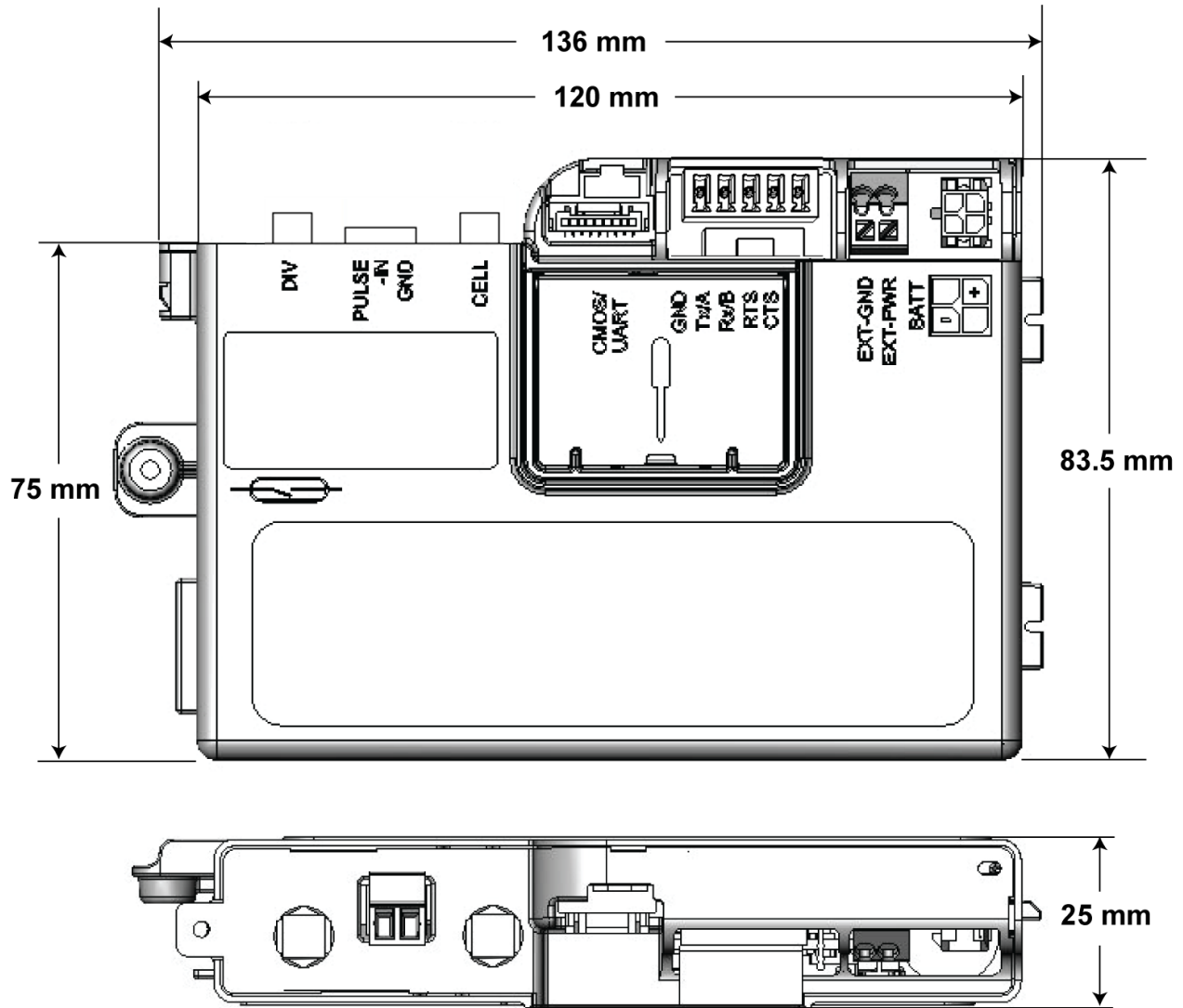

The figure below illustrates the placement of different interfaces available in a Cloud Link 4G Modem device.

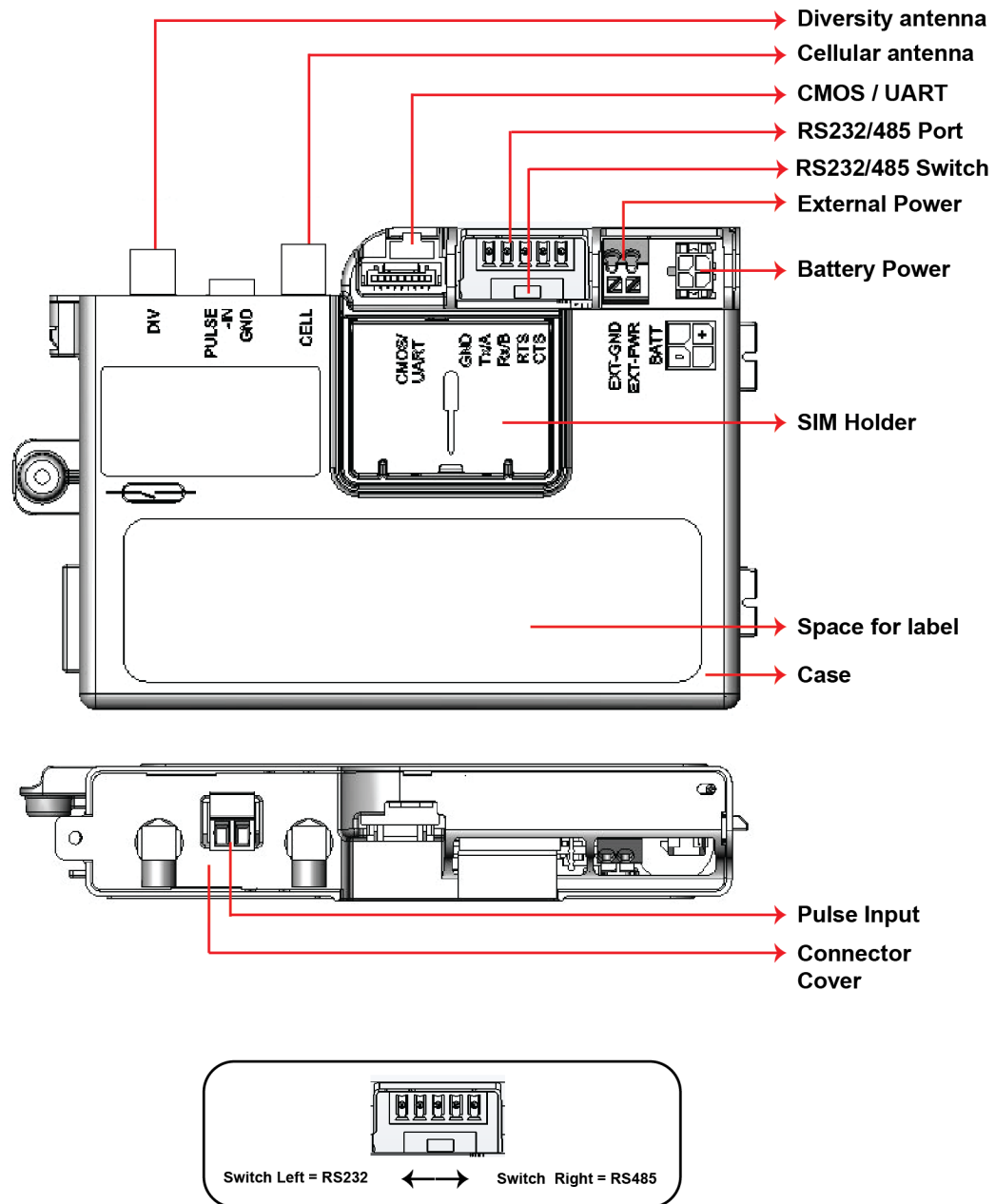

## 3.2 Power options

The Cloud Link 4G Modem device supports the following power supply options :

1. An optional second lithium D cell to supply power.
2. External DC power with battery backup, typically coming from a 12 V type battery, backed by a solar charger (Maximum 30 V).
  - There are two power connectors, one for a primary source up to 30 Vdc, and the other as backup.

**Note:** Note: Backup power source is required in case Cloud Link 4G Modem is powered using external DC supply.

### 3.3 Antenna Options

The FXUB63 flexible ultra wideband antenna is designed to cover all working frequencies in the 698-3000 MHz spectrum. The antenna has a flexible body with excellent efficiencies on all bands, ground independent, with cable and connector for easy installation. The Cloud Link 4G Modem includes 2 FXUB63 antennas - a Diversity antenna and a Cellular antenna.

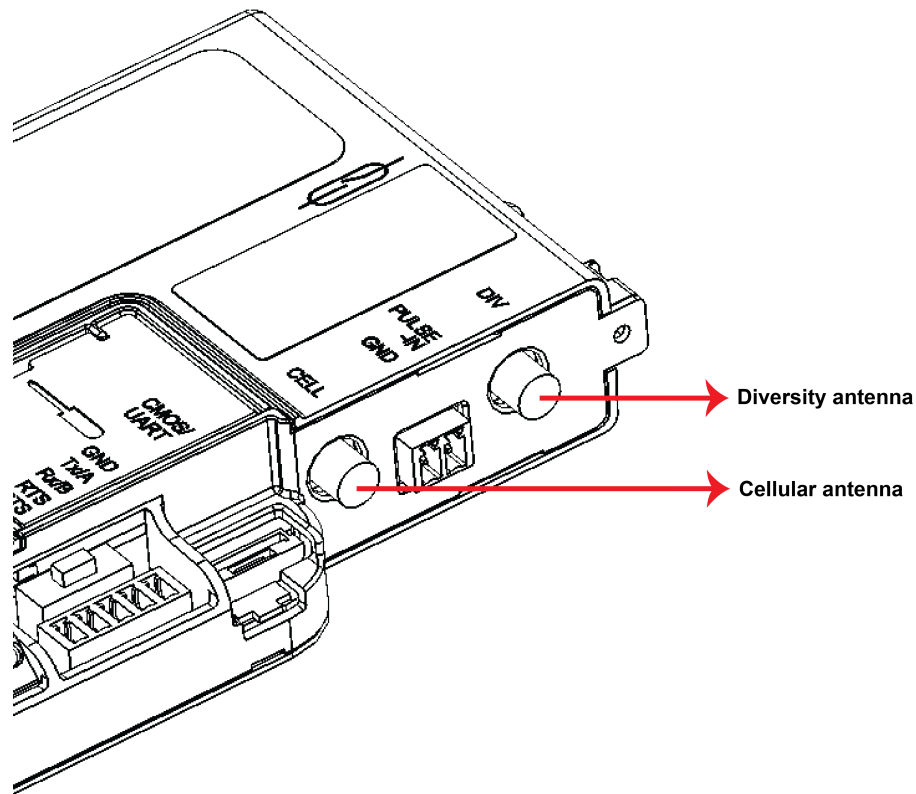

Cell antenna transmits and receives data; Diversity antenna only receives the signal. Antenna can be placed inside EVC enclosure or similar enclosure or in cases where signal strength is a concern. External antenna options are also supported.

**Note:** The RF cable used can be 20 cm long.

**Receive Sensitivity**

Parameter	Conditions	Min.	Typical	Unit
LTE connectivity	Band 2, 4, 5, 13 and 17			
Receiver Input Sensitivity@ ARP (ch. bandwidth 5MHz)	LTE 700 Band 17	-97	-102	dBm
	LTE 700 Band 13	TBD	TBD	dBm
	LTE 850 Band 5	-98	-104	dBm
	LTE AWS Band 4	-100	-103	dBm
	LTE 1900 Band 2	-98	-103	dBm

Cloud Link 4G Modem supports band 2, band 4 and band 13 for Verizon networks. Cloud Link 4G Modem supports the following frequency bands for other networks.

Frequency Bands	PLs8-X: GSM/GPRS/EDGE: Quad band, 850/900/1800/1900MHz UMTS/HSPA+: Triple Band, 850 (BdV) / AWS (BdIV) / 1900MHz (BdII) LTE: Five band, 700 (Bd13) / 700 (Bd17) / 850 (Bd5) / AWS (Bd4) / 1900MHz (Bd2)
-----------------	--

**Attention:** Antennas must be placed away from metallic parts like Batteries, Pressure Transducers, Grounding plates. Cell & Diversity antenna must not be kept close to avoid self interference. It is recommended to keep one antenna vertical and other antenna horizontal.



## 3.4 Installation Drawing

CONDITIONS OF SAFE USE:

- 1) FOR CANADIAN INSTALLATIONS, INSTALL IN ACCORDANCE WITH CANADIAN ELECTRICAL CODE PART 1.  
FOR US INSTALLATIONS INSTALL IN ACCORDANCE WITH THE NATIONAL ELECTRICAL CODE, ANSI/NFPA 70, ARTICLE 504.  
  
WARNING: SUBSTITUTION OF COMPONENTS MAY IMPAIR SUITABILITY FOR CLASS I, DIV2
- 2) "DIV" IS FOR CONNECTING DIVERSITY ANTENNA TO THE "**CLOUD LINK 4G MODEM**". THIS IS A RECEIVE ONLY ANTENNA. THIS MAY IMPROVE THE PERFORMANCE OF CELLULAR COMMUNICATION.
- 3) "PULSE-IN" IS A SWITCH INPUT FOR THE "**CLOUD LINK 4G MODEM**" AND ENERGY IS SUPPLIED BY THE "**CLOUD LINK 4G MODEM**".
- 4) "CELL" IS FOR CONNECTING CELLULAR ANTENNA TO "**CLOUD LINK 4G MODEM**". THIS IS A TRANSMIT AND RECEIVE ANTENNA.
- 5) "P1" IS A METROLOGY JUMPER INPUT AND ENERGY IS SUPPLIED BY THE "**CLOUD LINK 4G MODEM**". ONLY A WIRE JUMPER CONNECTING PINS 1 & 2 IS PERMITTED.
- 6) "CMOS" IS A CMOS LEVEL SERIAL INTERFACE CONNECTION FOR THE "**CLOUD LINK 4G MODEM**".
- 7) "RS232/RS485" IS A RS232/RS485 TYPE SERIAL INTERFACE CONNECTION FOR THE "**CLOUD LINK 4G MODEM**".
- 8) THE SIM CARD CONNECTION SHALL ONLY BE USED WITH SIM CARDS. THE SIM CARD MAY BE CONNECTED OR DISCONNECTED ONLY IN A NON-HAZARDOUS AREA OR WHEN THE DEVICE HAS BEEN DE-ENERGIZED.
- 9) FOR REMOTE POWER INSTALLATIONS CONNECT 4.8 - 30VDC TO THE "**CLOUD LINK 4G MODEM**" AT EXT-PWR CONNECTOR.
- 10) "**CLOUD LINK 4G MODEM**" AND BATTERY PACK CAN BE INSTALLED IN THE SAME ENCLOSURE WITH MINIMUM PROTECTION RATING OF IP20 OR APPROVED ENCLOSURE SUCH AS THE EC 350 OR THE "**CLOUD LINK 4G MODEM**" AND BATTERY PACK CAN BE INSTALLED IN A SEPARATE ENCLOSURE WITH MINIMUM PROTECTION OF IP20 OR GREATER.
- 11) THE "**CLOUD LINK 4G MODEM**" IS AVAILABLE WITH BATTERY PACK 51203165-100 WHICH IS COMPRISED OF A SINGLE CELL AND A Y CONNECTOR A SECOND BATTERY PACK (SAME MODEL) MAY BE CONNECTED TO THIS CONNECTOR TO CREATE A 2 CELL PARALLEL PACK. IF A SECOND PACK IS TO BE ADDED TO AN EXISTING PACK, THE USER SHALL ENSURE THAT BOTH PACKS ARE NEW AND UNUSED. THE SINGLE BATTERY PACK OR THE ASSEMBLY OF TWO BATTERY PACKS SHALL ONLY BE REPLACED IN A NON-HAZARDOUS ATMOSPHERE. THE CONNECTION OF MORE THAN 2 BATTERY PACKS MAY POSE A SERIOUS HAZARD.
- 12) NONE OF THE BATTERY PACKS SHALL BE RECHARGED UNDER ANY CIRCUMSTANCES.
- 13) THIS DEVICE SHALL BE INSTALLED IN A SUITABLE END USE ENCLOSURE PROVIDING A DEGREE OF PROTECTION ACCEPTABLE TO LOCAL AUTHORITY HAVING JURISDICTION.
- 14) ALL CONNECTION INTO THE "**CLOUD LINK 4G MODEM**" SHALL BE SOURCED FROM CLASS 2 CIRCUITS.

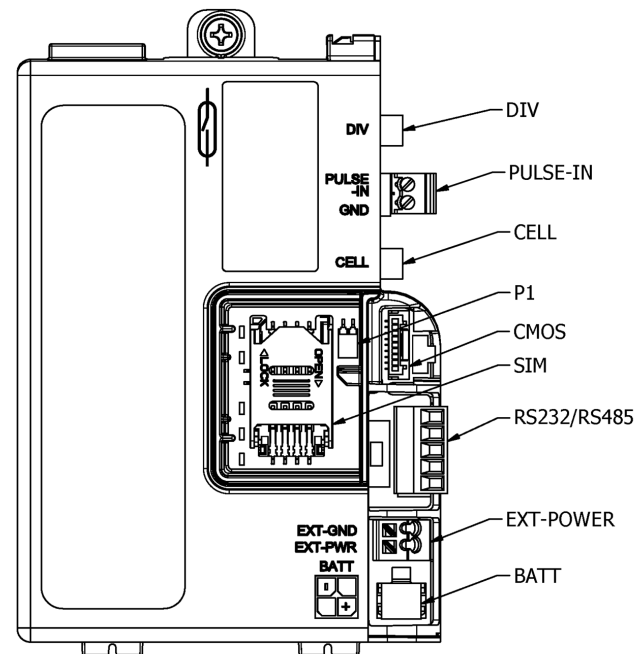

<small>DIMENSIONS ARE IN INCHES (METRIC mm) DRAW ALL SHARP EDGES UNLESS OTHERWISE SPECIFIED TOLERANCES ARE: FRACTIONAL ± .010 DECIMAL ± .005 ANGLE ± 1/2°</small>		<h1>Honeywell</h1>	
<small>THIS DOCUMENT CONTAINS CONFIDENTIAL AND PROPRIETARY INFORMATION OF HONEYWELL AND NEITHER IT NOR THE INFORMATION CONTAINED THEREIN SHALL BE DISCLOSED TO OTHERS OR DUPLICATED OR USED FOR OTHERS WITHOUT THE EXPRESS WRITTEN CONSENT OF HONEYWELL</small>			
<h2>INSTALLATION DRAWING</h2> <h3>CLOUD LINK 4G MODEM</h3> <h4>CLASS I, DIV2</h4>			
MATERIAL		DRAWN BY LEW	DATE 7/27/2016
		DESIGN ENG LEW	PROJECT 40-6114
INITIAL DRAWING	KNL 7/27/2016 2016-XXXX	COATING/FINISH	SCALE -
A			REV. A DWG SIZE B   SHT 1 OF 1

### 3.5 Field Installation

Cloud Link 4G Modem can be installed in an EC 350 Electronic Volume Corrector device using a mounting bracket as shown in the figure below. Position the 2 tabs of the Cloud Link 4G Modem case in the mounting bracket and use 6-32 screws to fix the device with the mounting bracket.

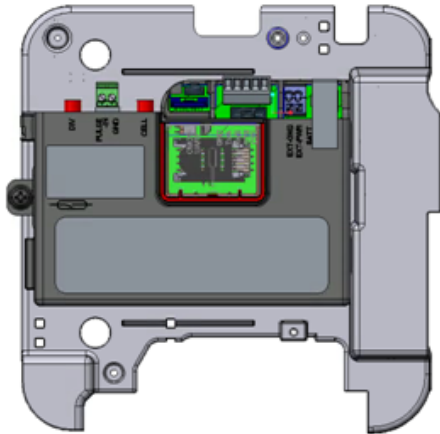

**UMB and Rotary Mount**

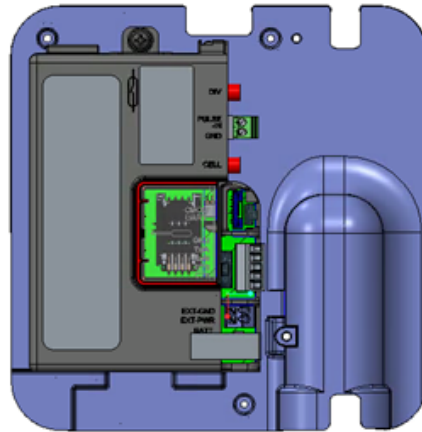

**Remote Mount**

# CHAPTER 4

## 4 Electrical Assembly

This chapter describes assembly of the different electrical components of a Cloud Link 4G Modem.

## 4.1 Power Supply options

Voltage Range	Type
3.0V to 3.6V	(Li-SOCI2) D-Cell + HLC (For pulse power)
4.8V to 30V	1. External Power supply (Ex: Solar power) 2. Alkaline Battery pack with external super capacitor.

- Humidity: Max 95% rH, non-condensing
- Peak current during transmission 3A @ 3.8V
- Duty cycle (GSM)during communication 0.577ms every 4.6ms.
- Operating voltage 4.8V to 30V
- Dynamic Response & Low Ripple

### 4.1.1 Power Port - Battery

Cloud Link 4G Modem battery connector connects the device to a single Lithium D-Cell with a voltage rating of 3.6V. Below are the battery specifications recommended to be used for Cloud Link 4G Modem.

Battery Part Number: 51203165-100

Data	Value
Voltage	3.6V (Max 3.9V)

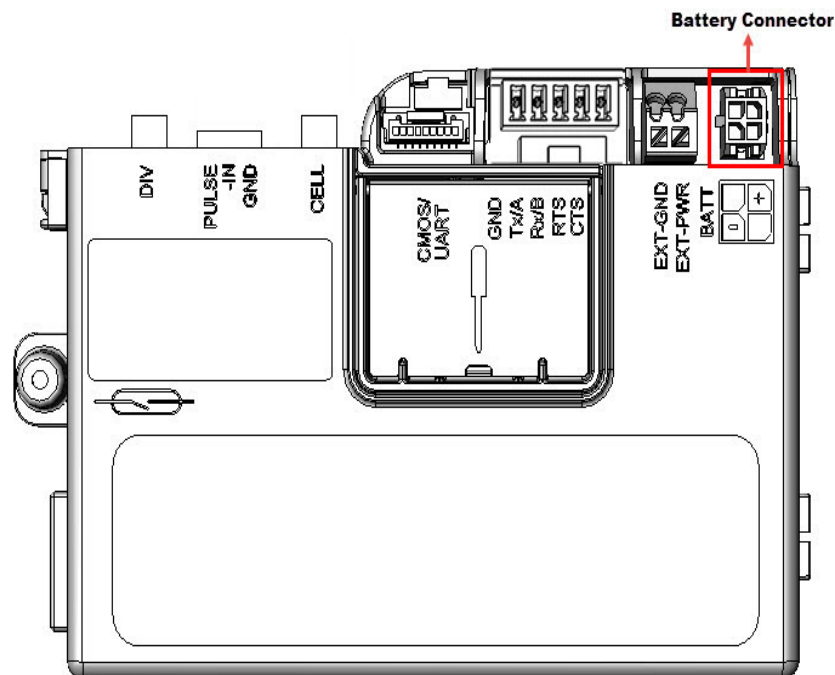

**Caution:** Do not use a Sierra Wireless power supply as it may damage the Cloud Link 4G Modem device.

**Note:** If a Cloud Link 4G Modem is connected to both external and battery power supply, and when the instrument is read using MasterLink, it appears as a battery powered device.

4.1.1.1 Battery pack drawing

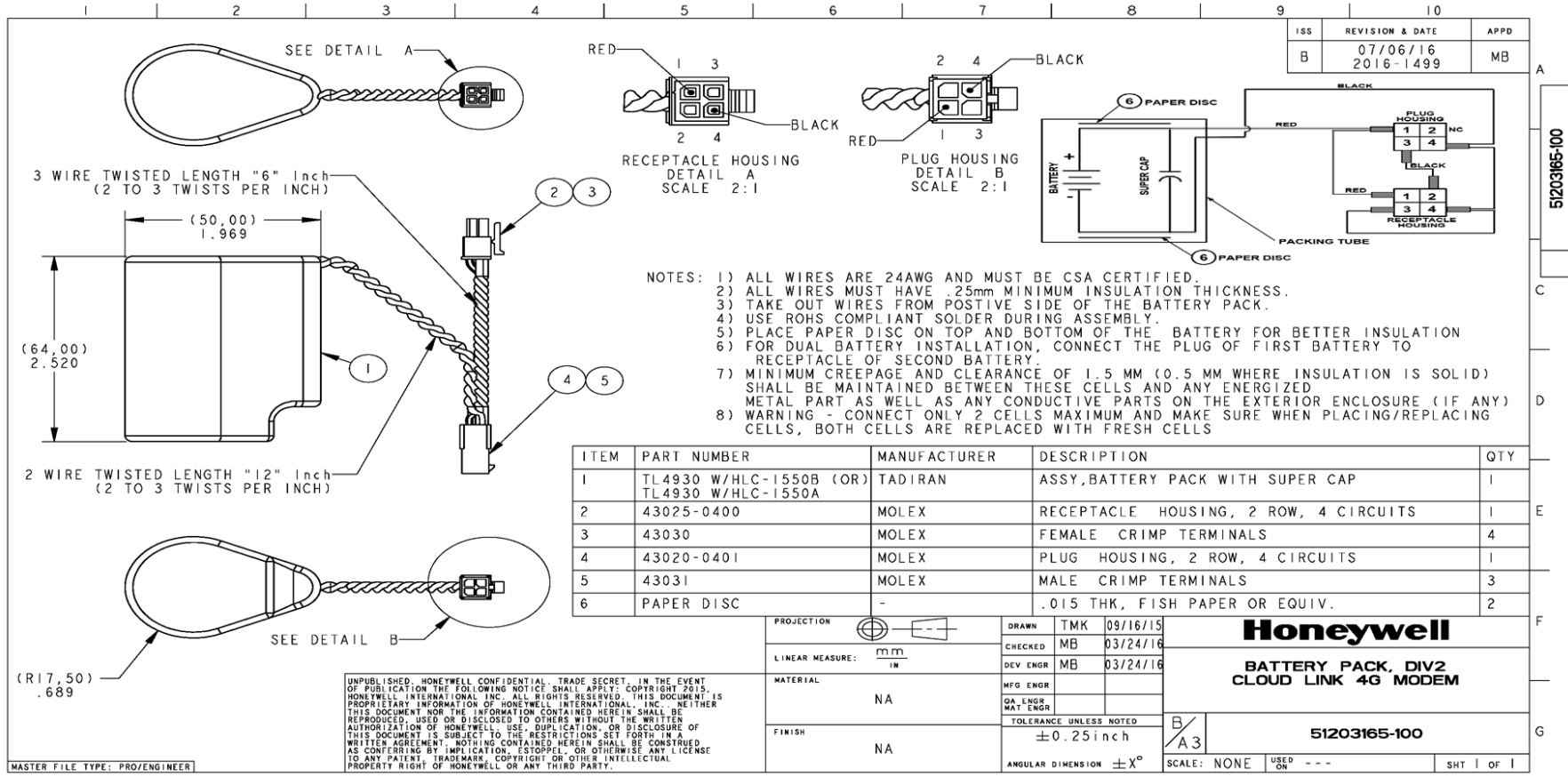

### 4.1.2 Power Port – External Supply

Cloud Link 4G Modem North America supports external power supply.

Data	Value
Operating Voltage	4.8V to 30V
Average Current	1A
Peak Current	2A

#### Pin Description:

- **EXT-GND:** Negative (-) terminal/Return of the external supply
- **EXT-PWR:** Positive (+) terminal of the external supply

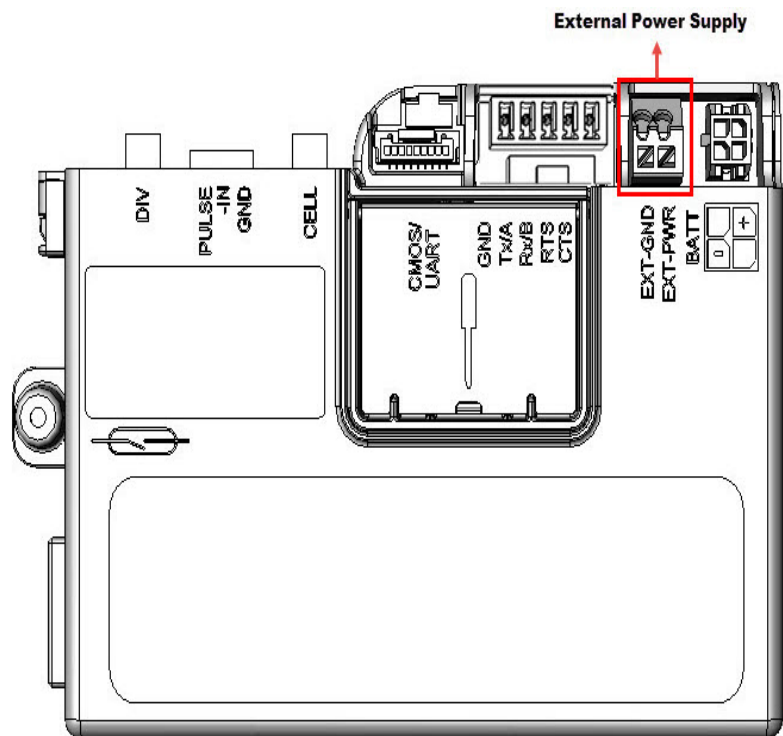

#### Connector on Cloud Link 4G Modem:

MPN: 250-102, MFR: WAGO: Spring Loaded 2-pin Terminal Block

## 4.2 Serial Communication – RS232/485

Cloud Link 4G Modem as a transparent cellular modem supports traditional RS232/RS485 interface (only one at a time). You can select either RS232 or RS485 by adjusting the position of the switch provided on the device.

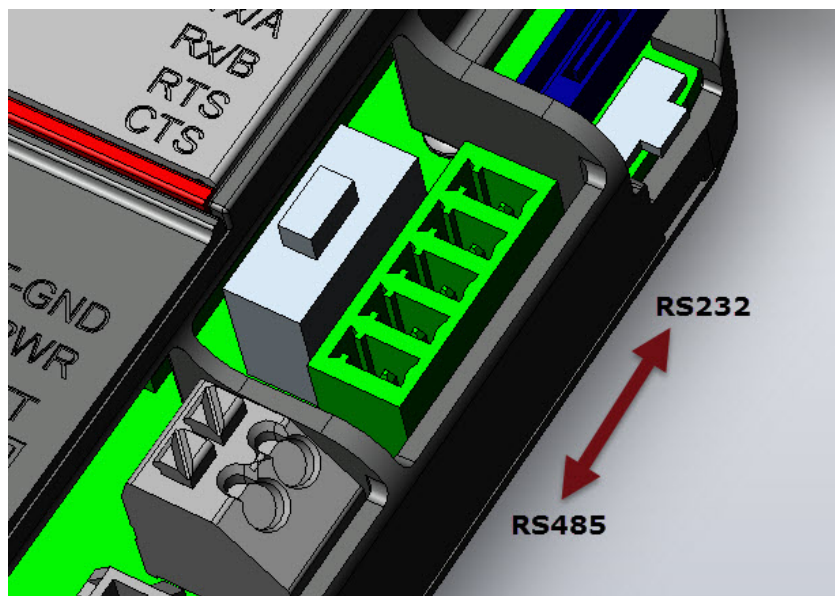

Pin#	Name	Description	I/O	Voltage Levels
1	Gnd	Ground		Ground
2	RS232 Tx (or) RS485 A	RS232 Mode: Transmit Line	O	+/- 3.7V (Min) +/-4V (Typ)
		RS485 Mode: Non-inverting Driver Output and Non-inverting Receiver Input	I/O	Diff Driver Output: 2.7V (typ)
3	RS232 Rx (or) RS485 B	RS232 Mode: Receive Line	I	+/- 10V (max)
		RS485 Mode: Inverting Driver Output and Inverting Receiver Input	I/O	Diff Driver Output: 2.7V (typ)
4	RS232 RTS	RS232 Mode: Request To Send (RTS)	O	+/- 3.7V (Min)
		RS485 Mode: NC (No Connection)		
5	RS232 CTS	RS232 Mode: Clear To Send (CTS)	I	+/- 10V (max)
		RS485 Mode: NC (No Connection)		



**Note:** While switching between RS232 or RS485, you must change firmware configuration using the appropriate item code. The RS485 cable supports a baud rate range from 9600 to 57600 bps. Maximum baud rate for RS232 interface is 115200 bps.

**Warning:** Older RS232 standards have a voltage level of +/- 18V. Using this voltage level can damage the Cloud Link 4G Modem device.

**Note:** RUID must be configured before using BLE communication. Configuration must be done using serial communication.

To keep power consumption low when not in communication, both transmitters (Tx & RTS) are to be turned off and RS485 will be in *Receiving Mode* in Cloud Link 4G Modem. To reduce power consumption, it is recommended to do same in the EVC or any other device where Cloud Link 4G Modem is interfaced. Cloud Link 4G Modem Controller can wake-up from deep sleep via Rx Line or CTS line of RS232 Interface (or) Rx line of RS485 interface.

- MPN: 0395011005  
Description: 5-Pin Terminal Block Header
- MFR: Molex
- MPN: 0395000005  
Description: 5-Pin Terminal Block Plug

#### **Cable for RS232:**

Cloud Link 4G Modem supports up to 30m (100ft) long cable for RS232 interface with shielded cable. Shield of RS232 cable must be terminated to Earth at one point to make interface immune to EMI/EMC.

#### **Recommended RS232 Cable:**

MPN: 9941 060100

MFR: Belden

Description: 5-Conductor Low Capacitance Shielded Cable of Length 30m (100ft).

**Cable for RS485:**

Cloud Link 4G Modem supports up to 30m (100ft) long cable for RS485 interface at a baud rate of 9600bps with Shielded Cable. Shield of RS485 cable must be terminated to Earth at one point to make interface immune to EMI/EMC.

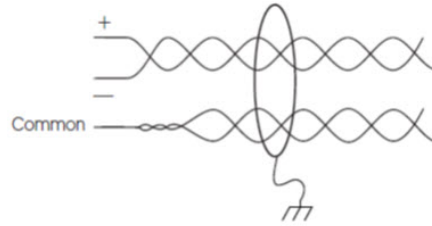

**Recommended RS485 Cable:**

MPN: 8332 060100

MFR: Belden

Description: 2-Pair Low Capacitance Shielded Cable of Length 30m (100ft).

## 4.3 Pulse Counter

Cloud Link 4G Modem supports 1-channel pulse-counting input up to 10 pulses per second with a minimum pulse width of 25 mS; It is to provide additional redundancy on the UMB pulse input front end. A pulse input from the UMB is wired to this additional pulse input. The EVC will read the pulse counter information recorded in the Cloud Link 4G Modem using AT commands and compare it with its own pulse accumulation register and raise alarm if any mismatch in accumulation. Pull-up resistor in Cloud Link 4G Modem can drive ~30uA of wetting current.

The pulse counter in Cloud Link 4G Modem is not MID/MC certified, cannot be used for billing.

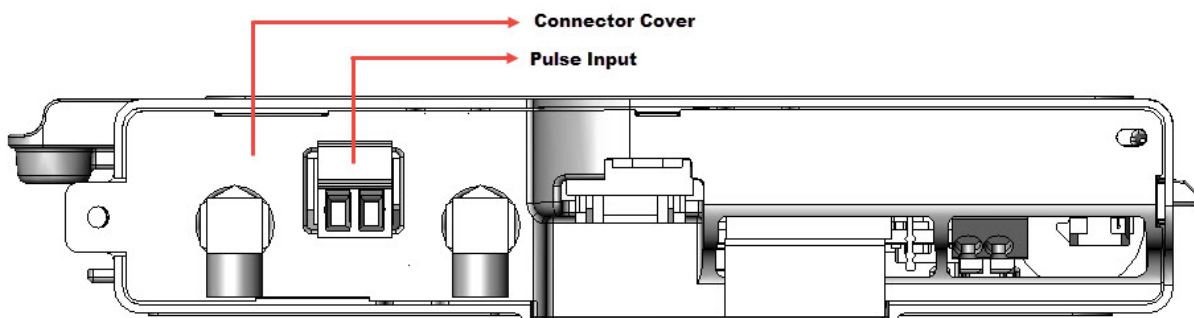

### Connector Details:

- MPN: (39512-1002)
- MFR: Molex

## 4.4 Antenna Interface

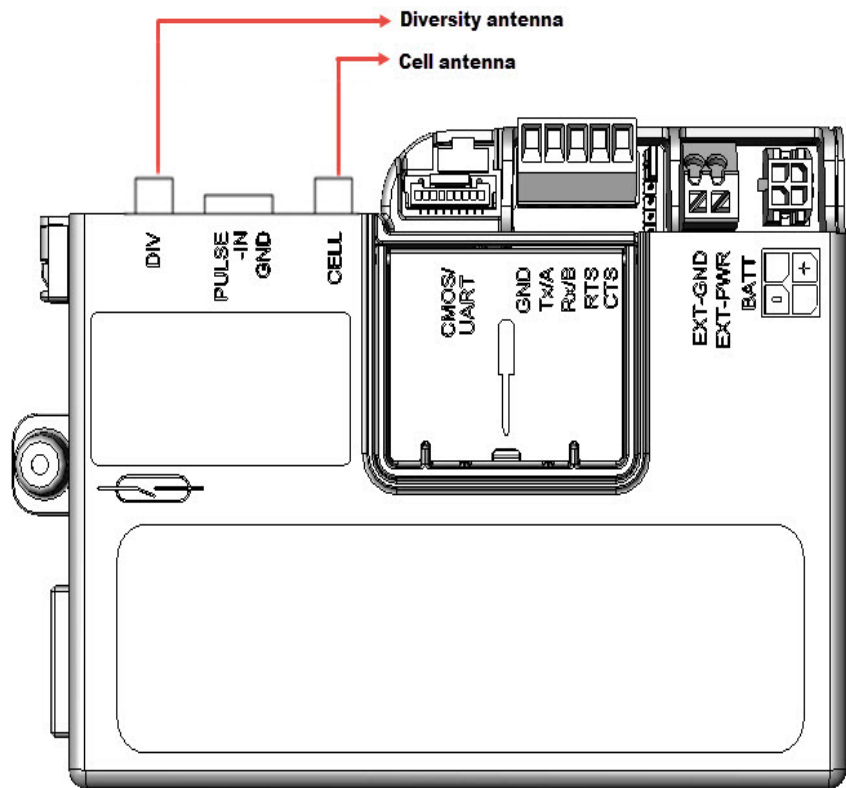

### Connector Specs:

- MPN: 73251-1150
- MFR: Molex
- Description: Edge Mounted SMA connector

### Recommended Antenna:

- HPN: 51508416-100
- Description: Octa-Band LTE Antenna (Bands 700/750/850/900/1800/1900/2100/2700 MHz)

## 4.5 Magnetic REED Switch

Magnetic Reed Switch in Cloud Link 4G Modem enables field technician to swipe a hand-held magnet near Reed switch in order to initiate a call.

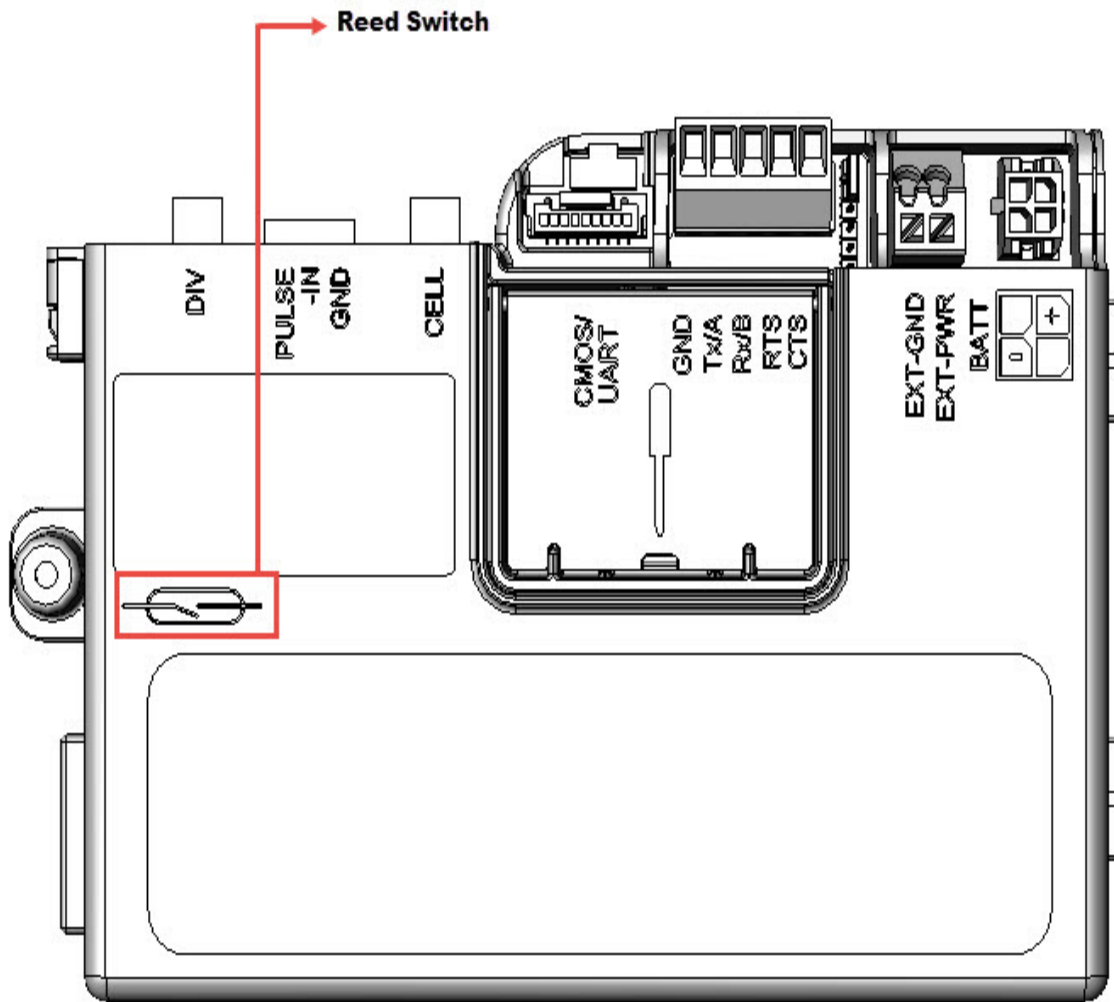

## 4.6 SIM Card

This connector on Cloud Link 4G Modem holds the cellular radio Standard SIM card. Cloud Link 4G Modem supports both 1.8V (Class C) and 3.0V (Class B) version SIM cards.

Lift the SIM cover to place the SIM card. Slide back the internal holder and flip it open.

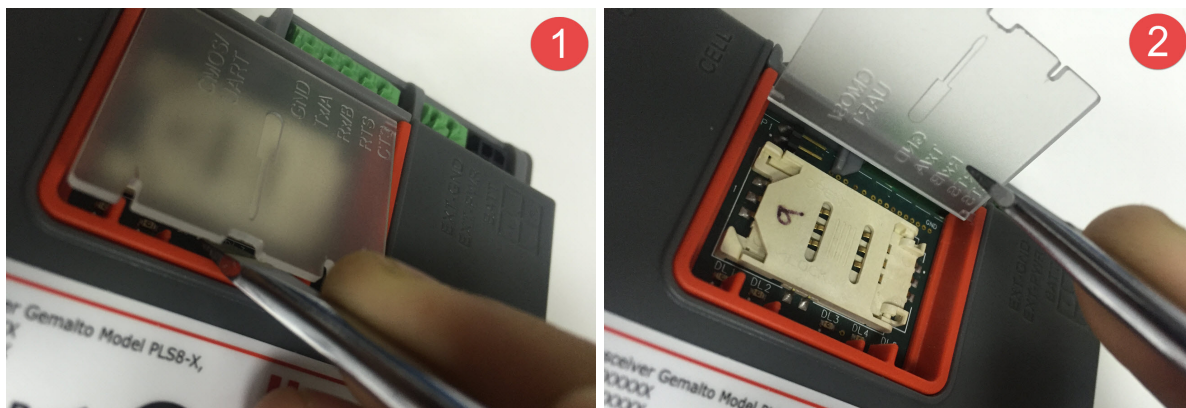

Insert a SIM card in the slot provided and close the cover.

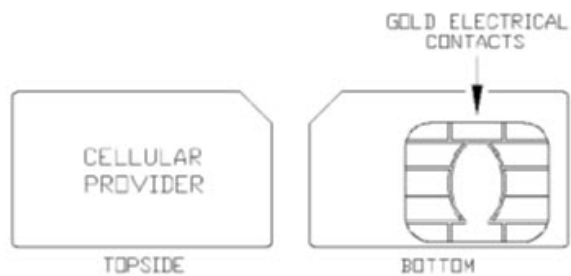

Typical SIM Card

### Procedure to switch from Non-Verizon to Verizon mode

Configure the following item numbers:

Item Number	Description	Value
3071	Verizon enable	1 0 = disable 1 = enable
3021	ModemIPType	2 0 = IPV4 1= IPV6 2 = IPV4V6
3016	Fetch Radio Parameters	1 0 = Disable 1 = Enable
3022	Packet service Connection Command	ATD*99***3#
3064	Manual APN Enable	1 (default) 0= disable 1= enable
3023	Access point name	

**Note:** If you enable 3064, then you need to manually configure 3023 based on the regional access point name. If 3064 is disabled, then then 3023 is automatically populated.

Disconnect the Cloud Link 4G Modem, install the SIM card, and then perform a factory reset.

Typically, if the Cloud Link 4G Modem is used with EC 350, then it takes about 60 seconds for the modem to boot up. if the Cloud Link 4G Modem is used with MiWiress device, it takes about 120 seconds for the modem to boot up. This may vary based on the SIM parameters.

If Manual APN is disabled for for Verizon (during a SIM change), it appozimately takes 4 minutes for the instrument to restart. This duration can be modified by altering item number 3074. This item number has to be set when Verizon Static IP SIM is used.

### Procedure to switch from Verizon to Non-Verizon mode (AT&T,Airtel,Vodafone etc)

Configure the following item numbers:

Item Number	Description	Value
3071	Verizon enable	0 0 = disable 1 = enable
3021	ModemIPType	0 0 = IPV4 1= IPV6 2 = IPV4V6
3016	Fetch Radio Parameters	1 0 = Disable 1 = Enable
3022	Packet service Connection Command	ATD*99#
3023	Access point name	

Disconnect the Cloud Link 4G Modem, install the SIM card, and then perform a factory reset.



## 4.7 BLE (Bluetooth Low Energy)

Cloud Link 4G Modem supports Bluetooth Low Energy (BLE) for local communications up to 30m (100ft) (Line of Sight). The Max transmit power from BLE is +8dBm and receiver sensitivity of -98dBm. The antenna of BLE is inside Cloud Link 4G Modem, no provision for external antenna is given for BLE.

In order to connect a Cloud Link 4G Modem with MasterLink iOS app, you need to perform a bluetooth pairing first. Cloud Link 4G Modem supports two types of pairing methods

- Just Works (no EVC dependency)
- Passkey entry (only with EC 350)

## 4.8 LED Indicators

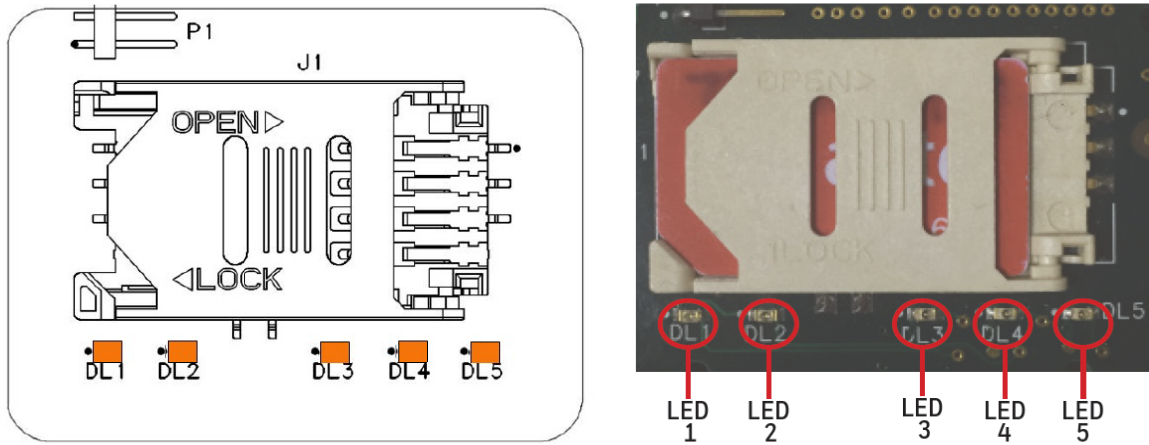

**Note:** LED functionality works only when the magnetic switch is enabled

### LED 1



Call established	High Speed LED blink (8 blinks per second)
Call establishment in progress	Medium speed LED blink (2 blinks per second)
Call establishment fail	Low speed LED blink (1 blink per second)
No Network connection	LED off

### LED 2

RSSI excellent	5 blinks per second
RSSI good	2 blinks per second
RSSI fair	1 blink every second
RSSI poor	1 blink every 2 seconds
No signal	1 blink every 5 seconds
no RSSI	LED OFF

				LED OFF
LED 3	LED 4	LED 5		LED ON

LED 3		LED 4		LED 5		Number of blinks	Separator
All LEDs blink at once							
	1 blink		1 blink		1 blink		Low Super Capacitor voltage
	1 blink		1 blink		2 blinks		External OTA Firmware upgrade flash memory Fault
	1 blink		1 blink		3 blinks		BLE UART communication fail
	1 blink		2 blinks		1 blink		BLE MAC address not configured
	1 blink		2 blinks		2 blinks		Modem UART communication fail
	1 blink		2 blinks		3 blinks		Config data checksum error
	1 blink		3 blinks		1 blink		IP Address or port # not configured
	1 blink		3 blinks		2 blinks		Security Certificate Error
	1 blink		3 blinks		3 blinks		Low Battery Capacity Indication
	2 blinks		2 blinks		1 blink		External Data flash memory Fault
	2 blinks		2 blinks		2 blinks		Network comm fail

	2 blinks		2 blinks		3 blinks	SIM Card Error
All LEDs blink three times						Cloud Link 4G Modem Microcontroller power cycle occurred
All LEDs blink two times						A condition occurred that caused the program to abort and restart, indicating a possible problem with the Cloud Links internal circuitry or program

**Note:** LED errors will remain active for 15 minutes. They will blink only when an emergency call is activated.

# CHAPTER 5

## 5 Configuring Cloud Link 4G Modem

This chapter describes the configuration of a Cloud Link 4G Modem device using the MasterLink iOS application.

## 5.1 Working Modes

The Cloud Link 4G Modem has 2 operating modes:

1. **Standalone mode:** where the modem functions as an independent device
2. **Integrated mode:** where the modem is connected and used with an EVC device.

## 5.2 Getting started with MasterLink iOS application

MasterLink iOS application is available on the iStore. For more information on installing and getting started with the MasterLink iOS application please refer to MasterLink help from the Honeywell Process Website (<https://www.honeywellprocess.com>).

### 5.2.1 Login and Registration

After you have installed the MasterLink iOS application, you need a valid license key. Your company's site administrator can generate a license file and a user-name that is sent to you in an e-mail. From the e-mail, you can open the license file in MasterLink App. You can then use your user-name and password to register.

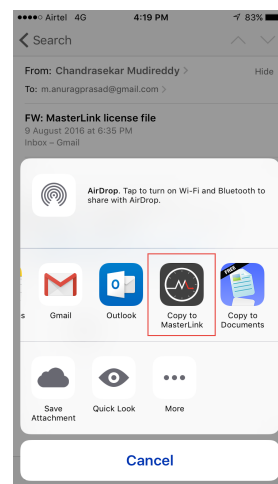
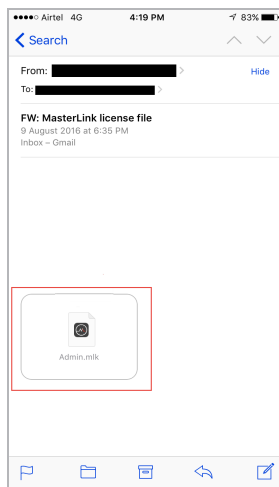

1. Tap and hold / or long-press the attachment
2. Select 'Copy to MasterLink' and open the license file

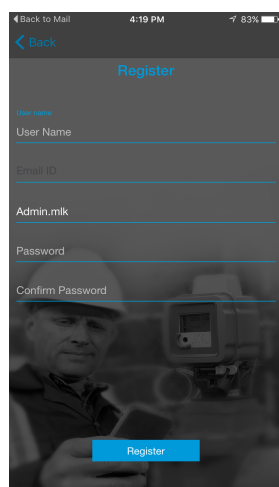

3. Register with your credentials

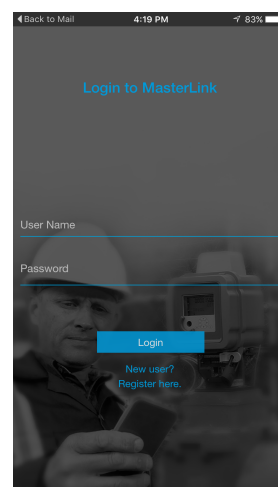

4. login with your credentials.

## 5.2.2 Adding a New Site

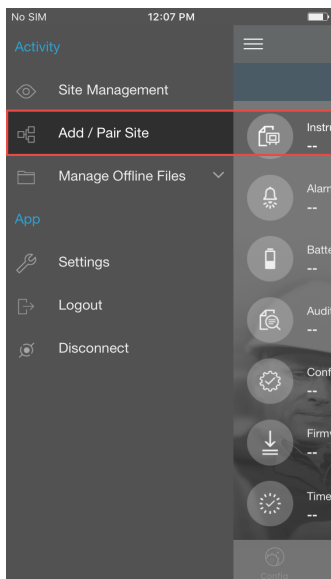

1. Select Add / Pair Site

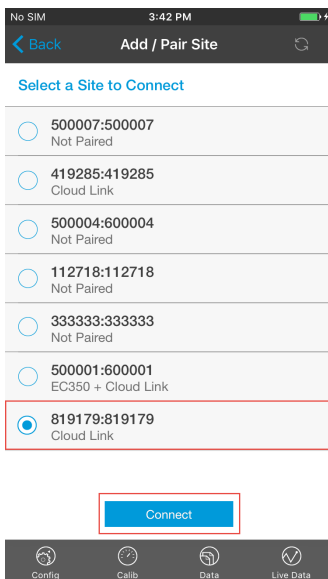

2. Select device from the list

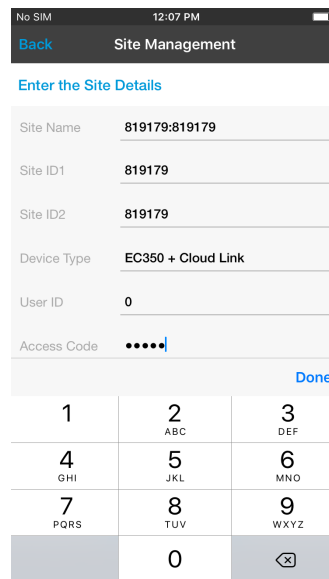

3. Enter the Site / device details

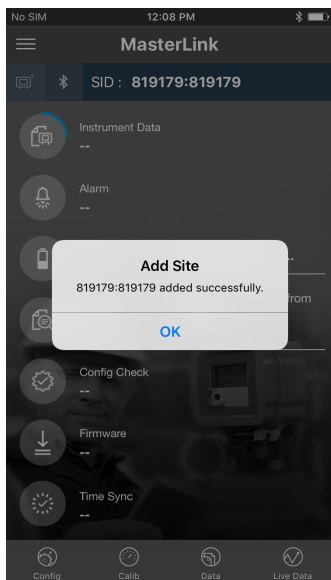

4. Site added successfully

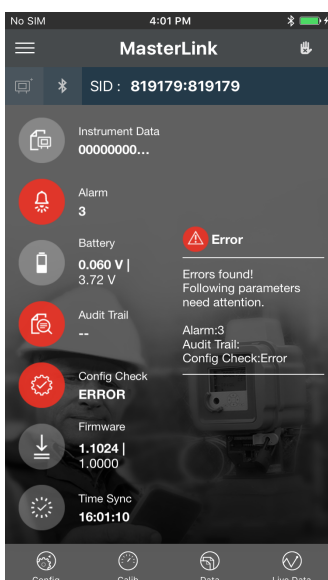

5. Dashboard appears



**Attention:** SiteID 1 or SiteID 2 must be a non-zero value. If either of them has a value equal to zero, then you must reconfigure it to a non-zero value using MasterLink desktop application connected using serial interface.

### 5.2.3 Connecting to Existing Site

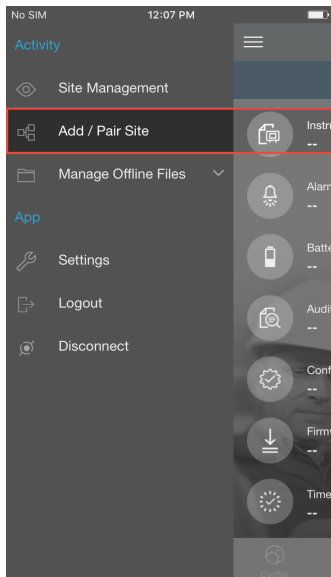

1. Select Add / Pair Site

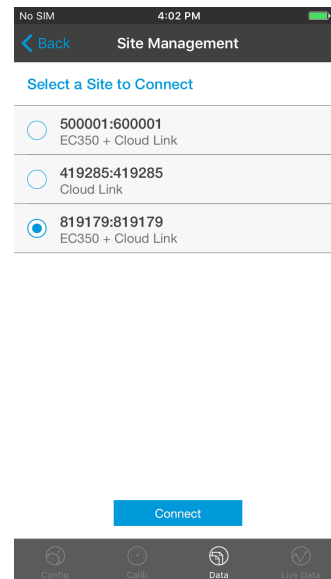

2. Select device from the list

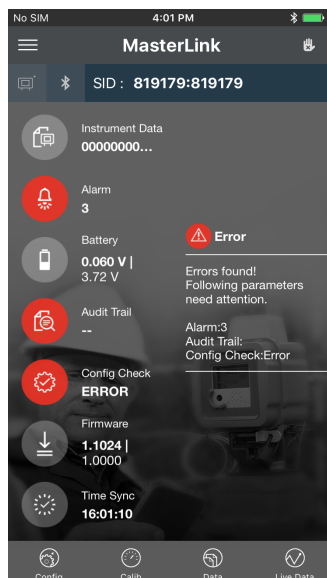

3. Enter the Site / device details

MasterLink automatically connects to an existing site if the instrument is authorized to connect automatically. If there are multiple sites in the vicinity, then you will be prompted to select a site.

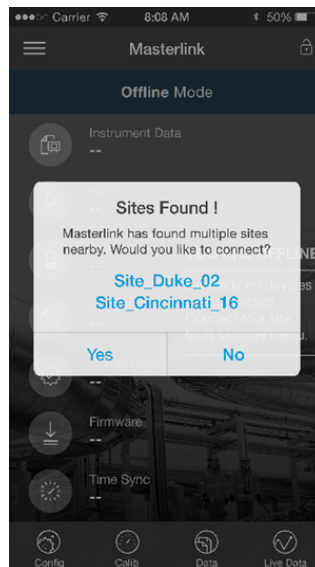

**Warning:** Deleting an existing site does not remove the device pair settings on the mobile device.

## 5.3 Bluetooth Pairing with MasterLink iOS application

Every Cloud Link 4G Modem device has a unique IMEI and RUID numbers. It is recommended to keep a note of these numbers as they can be used for identifying the device. RUIDs are used to identify a device using MasterLink desktop application or using PowerSpring.

### 5.3.1 Pairing with Just Works (without passkey)

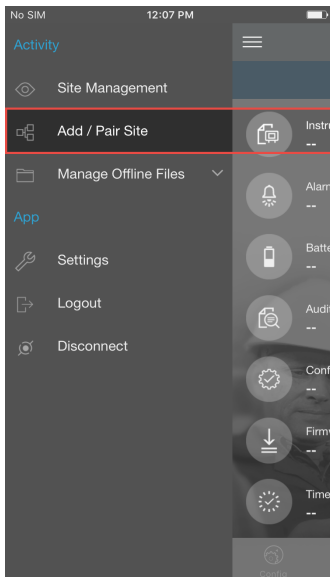

1. Select **Add / Pair Site**

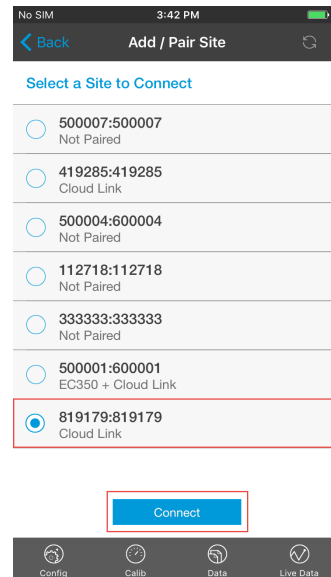

2. Select Cloud Link device from the list

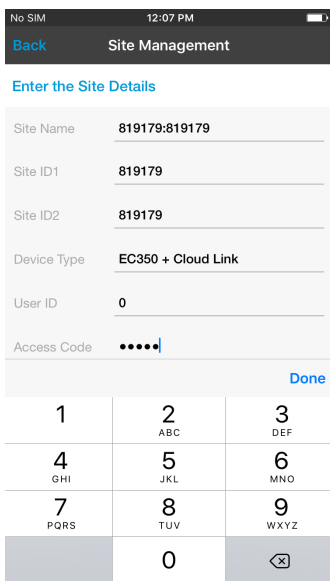

3. Enter the Site / device details

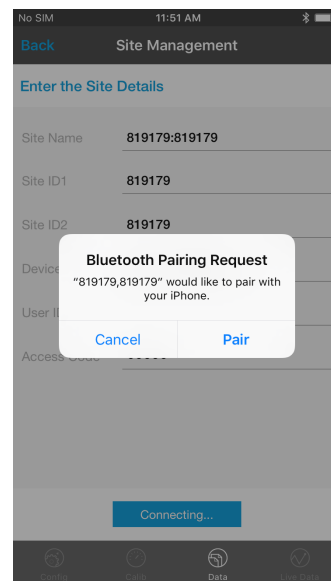

4. Tap **Pair** to complete the pairing process

### 5.3.2 Pairing with Passkey Entry

Passkey entry bluetooth pairing works only when the Cloud Link 4G Modem is used in integrated mode. Here's a high level overview of how passkey entry bluetooth pairing works.

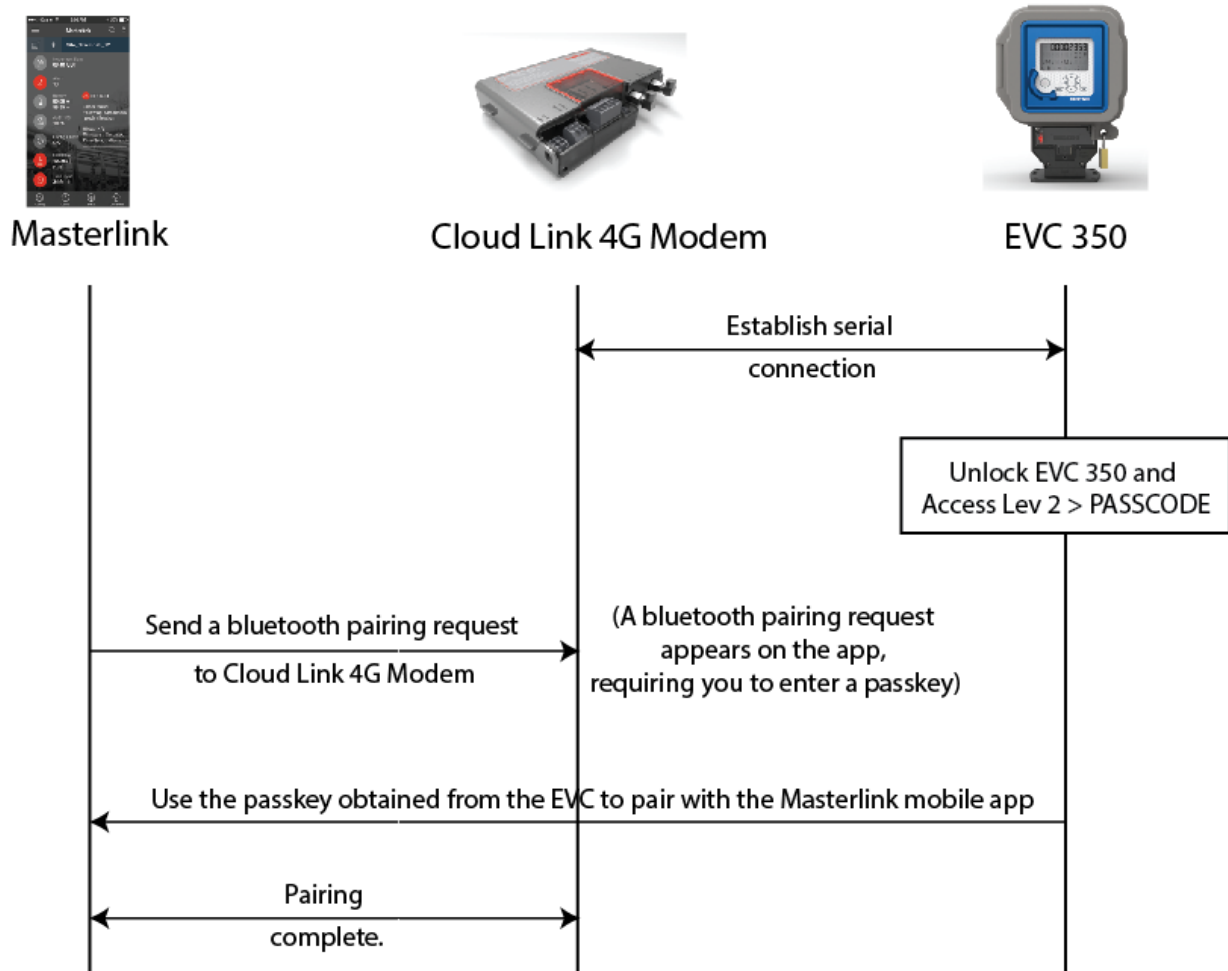

To pair using passkey:

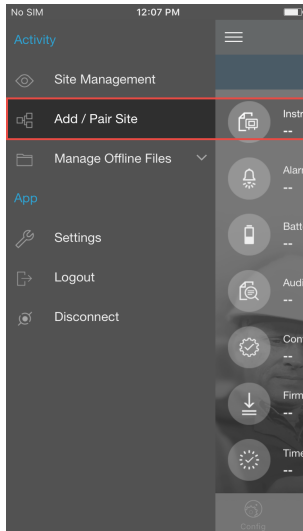

1. Select Add / Pair Site

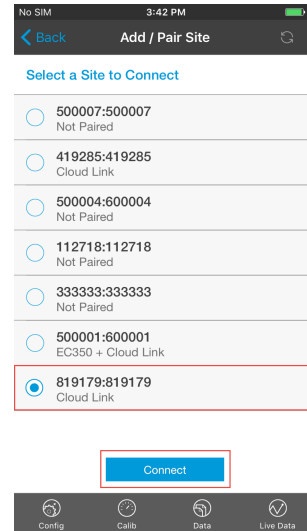

2. Select Cloud Link device from the list

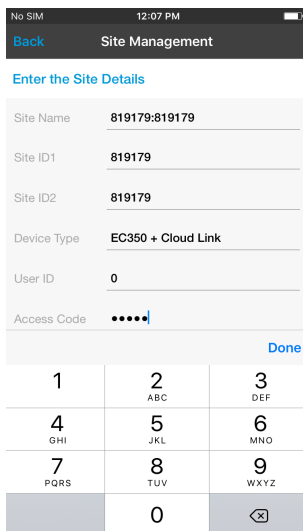

3. Enter the Site / device details

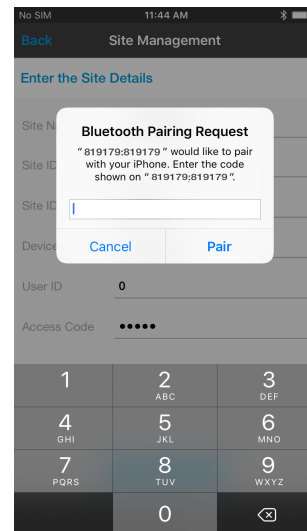

4. Enter the passkey obtained from the EVC and then tap Pair.

**Note:** The passkey must be entered within 40 seconds. The passkey is valid for 40 seconds after which it expires. If the passkey expires, you need to obtain a new passkey, and start all over.

## 5.4 Item Reference

ITEM Number	Parameter	Parameter Description
3002	Cloud Link 4G Modem Serial Number	Cloud Link 4G Modem Serial Number
3003	Cloud Link 4G Modem Manufacturing Date DD:MM:YYYY:	Cloud Link 4G Modem Manufacturing data
3004	Radio IMIE number	Radio identification number
3005	Change Battery	Reset Battery flag clears previously charge consumed data
3006	Advance Low Battery Indication (in days)	Advance Low Battery Indication (in days): Maximum allowed is 255 days and Min allowed is 15
3007	Battery Type	SINGLE_BATTERY_PACK,DUAL_BATTERY_PACK,QUAD_BATTERY_PACK,ONE_BATT_ONE_SC_SEPARATE,EXT_PS_SINGLE_BATT_PACK,EXT_PS_DUAL_BATT_PACK,EXT_PS_ONLY,NO_SUFFICIENT_SUPPLY
3008	Battery Charge Capacity	Battery Charge Capacity: is based on battery type
3009	Super Cap Low voltage to drop the call	Super cap voltage reading
3010	Battery Voltage Critically low Threshold	Battery critically low Threshold value
3011	Available % battery life	Percentage battery life
3012	Super Cap Charge Availability (in sec)	Super cap voltage in seconds
3013	Battery Voltage	Battery voltage
3014	Supercap Voltage	Super cap voltage
3015	Battery Charge Consumed	Battery Charge Consumed
3016	Fetch radio parameters	0 - Disable 1 - Enable
3017	SSL enable / Disable	0 - Disable 1 - Enable
	Security - keys	
	Security Signed Certificate	
	Security - CA Certificate	
3018	IPSec enable / disable	0 - Disable 1 - Enable
	Security - keys	
	Security Signed Certificate	
	Security - CA Certificate	
	User Log in ID	User Log in ID: admin

ITEM Number	Parameter	Parameter Description
	User Log in Password	Password: Default : 123456
	User Log in ID	User Log in ID: admin
	User Log in Password	Password: Default : 123456
3019	IP Security Cert Expiry Status	0 - Valid 1 -Expired
3020	SSL Security Cert Expiry Status	0 - Valid 1 -Expired
3021	Mobile or Simple Internet Protocol	0 = Simple Internet Protocol (SIP) 1 = Mobile Internet Protocol (MIP)
3022	Packet Service Connection Command	This command initiates a packet (internet) connection This can be different for different cellular providers, but generally the universally-accepted string is"ATD*99#"
3023	Access Point Name	This is the name of the gateway to the service provider's internet service. Examples: m2m@T-Mobile.com or isp.cingular
3024	PAP / CHAP Enable	0 = None 1= PAP only 2 = CHAP only 3 = CHAP first and then PAP as a fallback if CHAP fails.
3025	PAP / CHAP User Nam	
3026	PAP / CHAP Pass Word	
3027	SIM PIN Number	A numeric string (ex: "54311") that protects the SIM card from being used by unauthorized persons.
3028	Cellular Session Timeout	10 sec - 300 sec
3029	SIM Number	
3030	Mobile Directory Number	
3031	Carrier Name	Mobile Carrier name
3032	Internet Protocol Version 4 or 6 (IPv4 or IPv6)	0 = IPv4 1 = IPv6
3033	Source Port Starting Number	
3034	Source Port Ending Number	

ITEM Number	Parameter	Parameter Description
3035	Maximum TCP/IP packet size	This defines the maximum data portion of the TCP/IP packet, which is usually referred to as the Maximum Segment Size, or MSS. Maximum is 65535 bytes. Legacy Ethernet v2 segment sizes were limited to about 1460 bytes.
3036	DNS or IP address	This parameter is to select IP address / DNS name  0- IP address  1- DNS
3037	Primary Destination IP Address (Client Mode) (Can be IPv4 or IPv6 address)	ASCII form size based on IPv4 or IPv6 address
3038	Primary Destination Port Number (Client Mode).	Destination port number
3039	Alternate Destination IP Address (Client Mode)	ASCII form size based on IPv4 or IPv6 address
3040	Alternate Destination Port Number (Client Mode)	Alternate destination port number
3041	Domain Name Server (DNS) #1	URL of DNS1
3042	Domain Name Server (DNS) #2	URL of DNS2
3043	Domain Name Server (DNS) #3	URL of DNS3
3044	Server Mode Friends (White) List Enable	0 - Disable  1 - Enable
3045-3054	Server Mode Friends (White) List(10 IP address)	Server White list IP addresses 1 - 10
3055	Device Wakeup time	Device wakeup time after receiving AT commands
3056	Number of total Items	Total number of Cloud Link 4G Modem item codes
3057	MI session timeout	BLE session timeout for both Cloud Link 4G Modem & EVC connection
3058	Last call / Known Signal Strengthl	Last call known signal strength
3059	Last Known Source IP Address	Last call IP address
3060	Last Known Source Port	Last call IP Port
3061	Modem server timeout	Server mode timeout



ITEM Number	Parameter	Parameter Description
3062	Modem Firmware Version	
3063	Radio Modem model	
3064	Select communication port to EVC	
3065	RS-232 / RS-485 Serial Port Baud Rate	
3066	CMOS Serial Port Baud Rate	
3067	RS-232 Serial Port Flow Control	
3068	CMOS Serial Port Flow Control	
3069	BLE Baud Enable	
3070	Include Baud in CONNECT Message	
3071	Always RING Port	
3072	Use Non-Verbose (Numeric) Response Codes	
3073	Serial Port Delay Before Sending Packet	
3074	Verizon Dynamic IP SIM startup delay	Required when the SIM is changed.
3075	RS485 enable	
3076	BLE MAC Address	
3077	BLE Device Name	
3078	Advertisement interval(in msec)	
3079	BLE Module Status	
3080	BLE firmware version	
3081	BLE stack versionversion	
3082	BLE forget all bonds	
3083	BLE host White List Enable	0 - Disable 1 - Enable
3084	BLE Last RSSI	
3085	BLE Security type	1-Just works 2- Passkey entry
3086-3093	BLE white list	

ITEM Number	Parameter	Parameter Description
3112	BLE conn interval	Advertisement interval max : data value in mSec
3094	Cloud Link 4G Modem Mode	Integrated Mode - 0 Standalone Mode - 1
3095	Remote Unit ID (RUID)	Default Value : 000001
3096	Running / Existing Firmware Version	Cloud Link 4G Modem firmware revision
3097	Running Firmware CRC check-sum	Cloud Link 4G Modem firmware checksum
3098	Down Loading Firmware Version	
3099	Firmware upgrade max packet size	
3100	Firmware image max size allowed	
3101	Coordinated Universal Time (UTC)	When the Cloud Link 4G Modem receives a time and date, it is relative to Coordinated Universal Time (UTC) which is essentially the same thing as Greenwich Mean Time (GMT).
3102	Date format type	0 = MM_DD_YY 1 = DD_MM_YY 2 = YY_MM_DD
3103	Cloud Link 4G Modem Boot-loader version	
3104	Cloud Link 4G Modem Boot-loader CRC	
3105	Immediate Call on Low-Battery Condition Enable	
3106	Immediate Call on Alarm Active Enable	
3107	Immediate call on for wrong login failure	
3108	Date	
3109	Time	
3110	Server mode IP address	
3111	Server mode IP port number	
3113	Pulse count	

ITEM Number	Parameter	Parameter Description
3114	Cloud Link 4G Modem board temperature	
3115	Cloud Link 4G Modem Configuration Change Event	
3116	Cloud Link 4G Modem Firmware Upgrade Event	
3117	Cloud Link 4G Modem Password Change Event	Password credential change
3118	Cloud Link 4G Modem POR counter	Cloud Link 4G Modem power on reset count Event
3119	Login Failure Event	Cloud Link 4G Modem login failure Event
3120	Low Battery Alarm Event	0 - Not Active 1 - Active
3121	Emergency Callin Alarm Event	0 - Not Active 1 - Active
3122	BLE transmit power	BLE transmit power
3123	BLE enable	BLE enable
3124	Last call Cellular service	Last call Cellular service
3125	Last call cellid	Last call Cellular ID
3126	Last cal Loc ID	Last call location identifier
3127	Last cal RSCP	Last call RSCP(3G)
3128	Last cal RSRQ	Last cal RSRQ(4G)
3129	Last cal MCC	Last cal MCC
3130	Last cal RSRQ	Last cal RSRQ
3131	Last cal Physical cell id	Last call physical cell id
3132	Last call Cellular RSRP	Last call Cellular RSRP
3133	Last call Cellular TAC	Last call cellular TAC
3134	Last call duration	Lats successful call duration
3135	Last call status	Last call status
3136	Pulse count enable	Pulse count enable
3137	Restore/Reset/Clear logs	Misc Item Action Input
3138	Modem server timeout	
3139	Remote Unit ID 2 (RUID)	

ITEM Number	Parameter	Parameter Description
3140	Temperature units	
3141	BLE number of bonds	
3142	MIWireless Enable	0 = for 350 (default) 1 = MiWiress (When this item number is changed, the instrument must be restarted)
3143	BLE start time	
3144	BLE stop time	
3425	Factory test access number	Access code to enter into factory mode
3426	Factory test mode status	
3427	Factory test item number	FT_MODEM_POWER_ON= 1, FT_MODEM_POWER_OFF= 2, FT_SIM_TEST= 3, FT_SRAM_TEST= 4, FT_DATA_FLASH= 5, FT_OTA_FLASH= 6, FT_SUPER_CAP_VOLTAGE = 7, FT_BATTERY_VOLTAGE= 8, FT_EXT_POWER_VOLTAGE = 9, FT_MAGNETIC_SWITCH= 10, FT_TEMPERATURE= 11, FT_BLE_MODULE= 12, FT_LED_TEST= 13, FT_SLEEP_TEST= 14, FT_MET_JUMPER= 16,
3428	Modem power ON Result	
3429	Modem power OFF Result	
3430	SIM test Result	

ITEM Number	Parameter	Parameter Description
3431	BLE test Result	
3433	Test data flash Result	
3434	Test OTA flash Result	
3435	Test SRAM	
3436	Magnetic switch status	
3437	Metrology jumper status	
3148	Cloud Link 4G Modem model number	
3149	PWA serial number	
3150	PWA revision number	
3151	IFT test result	
3152	FFT test result	
3153	Programming test result	
3154	EOL test result	
3155	FFT (Selective) Test Result	
3156	Last magnetic alarm time	
3157	Last battery alarm time	
3145	BLE Passkey	
3146	External Voltage	
3147	Alarm Call Retries	
3158	Security certificate issue time	
3159	Security certificate expiry time	

## 5.5 Device Configuration Over Bluetooth

**Note:** Configuration changes take effect immediately.

### 5.5.1 Configuration by Group

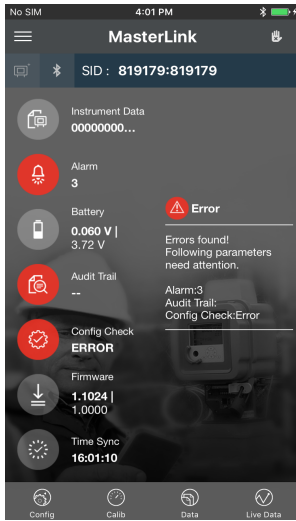

1. Tap Config

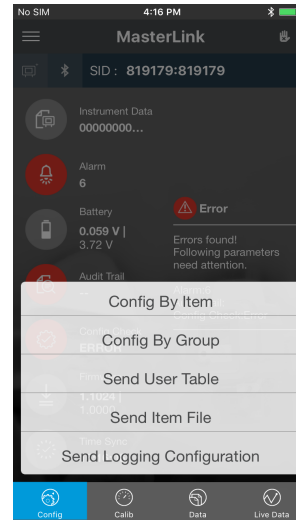

2. Tap Config by Group

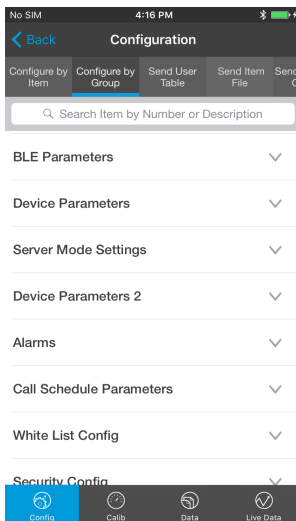

3. Select an item group

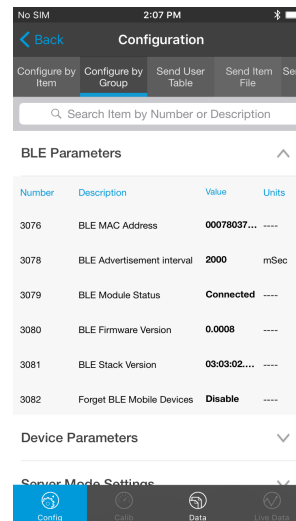

4. Configure the item values

## 5.5.2 Configuration by Item

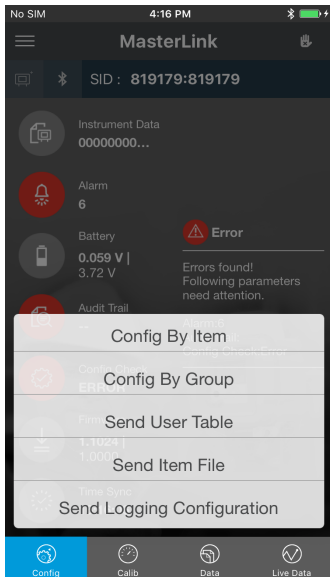

1. Tap Config > Config by Item

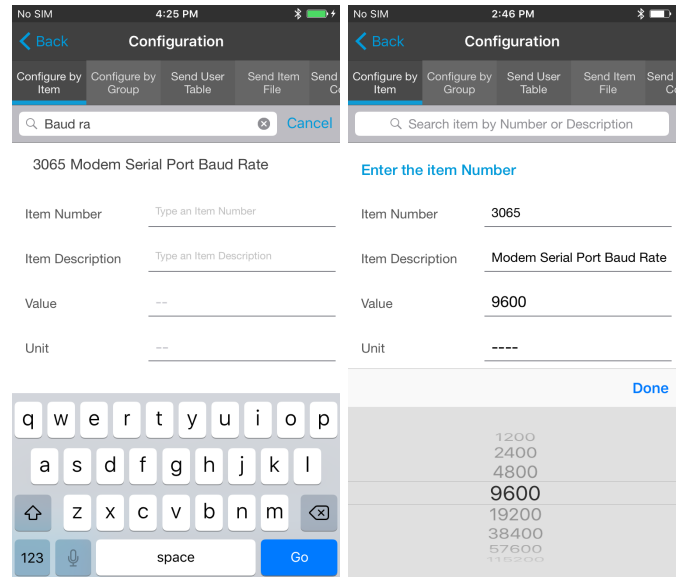

2. Configure item parameters

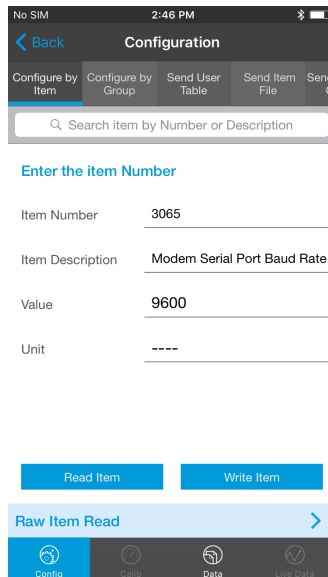

3. Select Write Item

## 5.6 Firmware Upgrade

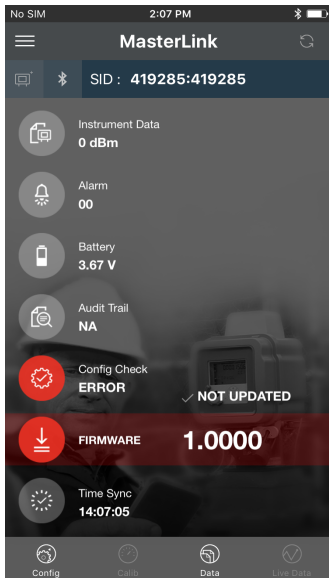

1. Tap Firmware

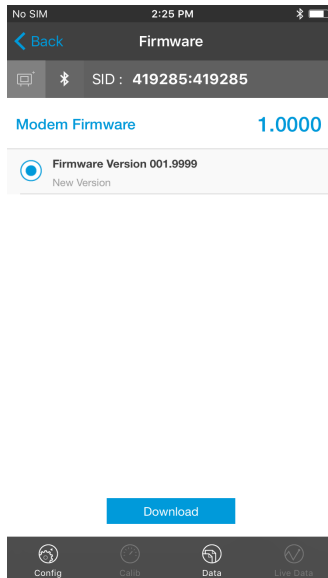

2. Select Firmware and tap Download

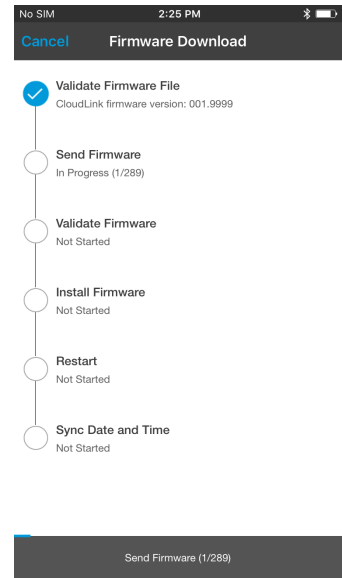

3. Firmware Validation

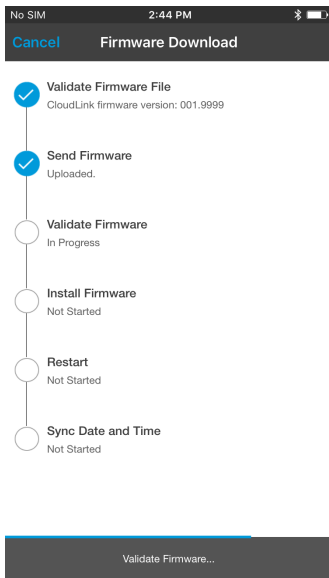

4. Send firmware to device

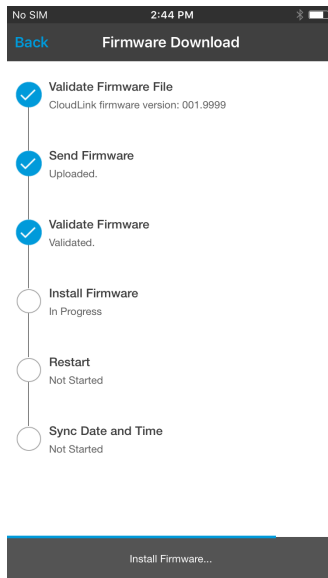

5. Validation

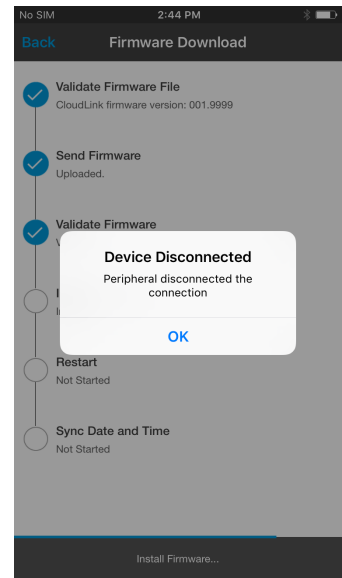

6. Device restarts



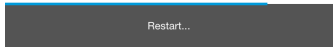
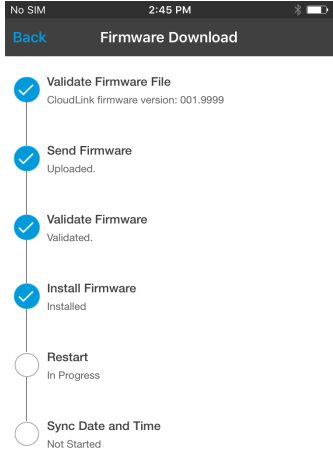

7. Installation in progress

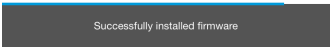
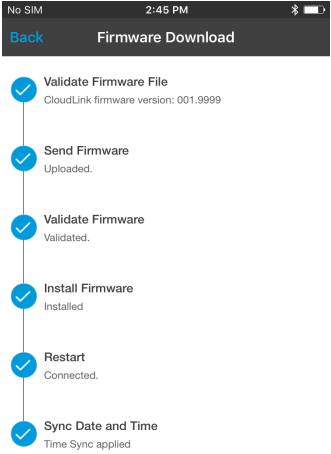

8. Firmware update completed

## 5.7 Server Mode

To configure server mode settings:

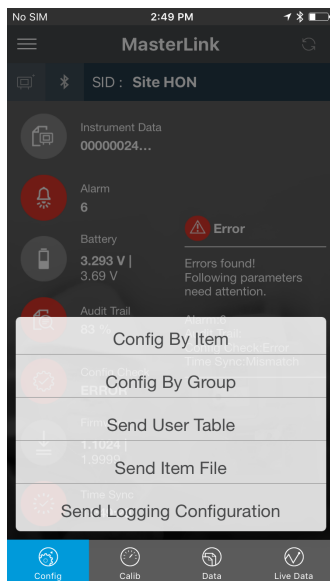

1. Select **Config > Config by Group**

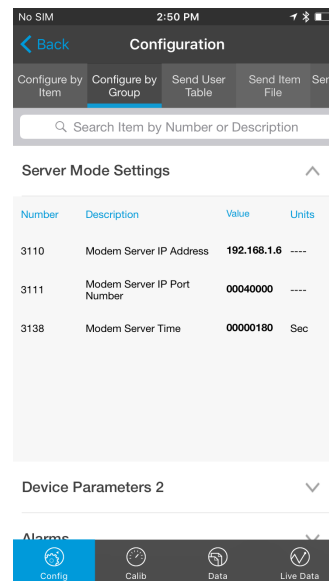

2. Select **Server Mode Settings** and the configure the server settings.

## 5.8 Pulse Counting

Cloud Link 4G Modem has a feature to count the pulses. This adds the advantage of getting redundant counts along with the counts from the actual sensor measured by the external EVC. To use this functionality, you need to enable and configure this feature.

To enable Pulse counts:

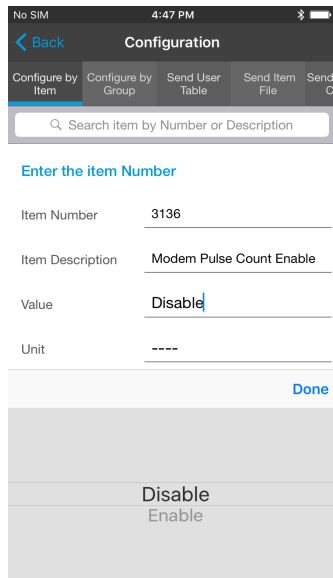

1. Enable Modem Pulse Count Enable

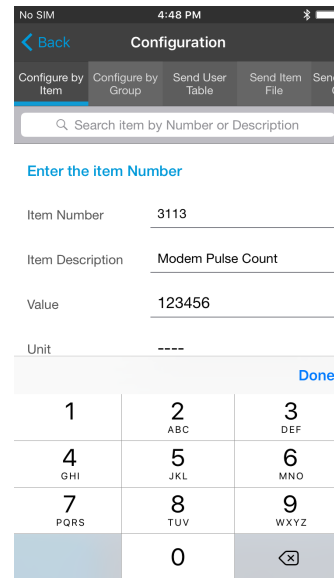

2. Configure Modem Pulse Count

## 5.9 Changing the Battery

After changing battery, perform a **Reset Battery** operation by modifying the *Modem Reset Battery* configuration item **3005**. This will reset/clear all the battery related counters for new battery. It is always assumed that only a new/fresh battery will be replaced as doing the "reset battery" operation will reload the battery capacity to full battery capacity.

Battery related parameters:

Number	Description	Value	Units
3005	Modem Change Battery	Clear	----
3006	Modem Advance Low Battery Indication	30	Days
3007	Modem Power Source Type	External...	----
3008	Modem Battery Capacity	0	Milli Colou...
3009	Modem Threshold Sleep	2.80	Volts
3011	Modem Available Battery Life	100.0000	%
3012	Modem Charge Available	00001039	Sec
3014	Modem Battery Voltage	3.69	Volts
3146	Modem Ext Supply Voltage	12.22	Volts
3140	Modem Temperature Units	Fahrenheit	----
3114	Modem Temperature	94.63	Fahrenheit

**Attention:** Always ensure that you perform a *Reset Battery* after changing the battery. This is to ensure that you have an accurate measurement of battery life.

## 5.10 Factory Reset

To perform a factory reset:

1. Short jumper P1 located near the SIM card slot.

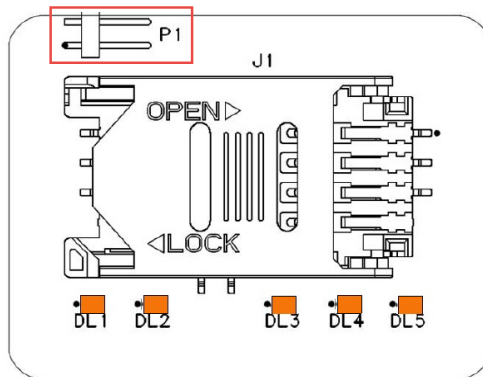

2. Perform a power reset.
3. Remove the P1 jumper after power reset is completed.

**Note:** Site IDs must be restored using serial interface. These SiteIDs must be non-zero value.

## 5.11 Time Sync

The *Time Sync* screen lets you sync your mobile time and date with the instrument time and date.

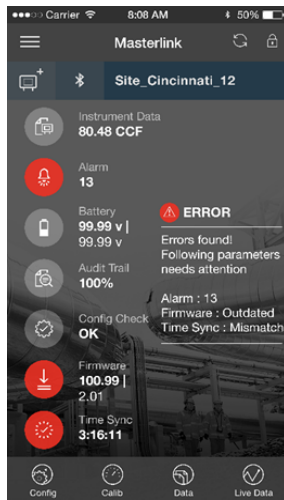

1. Tap on Time Sync

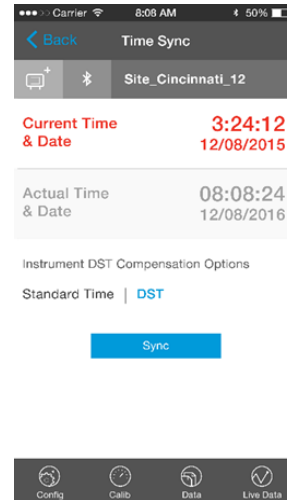

2. Tap on Sync

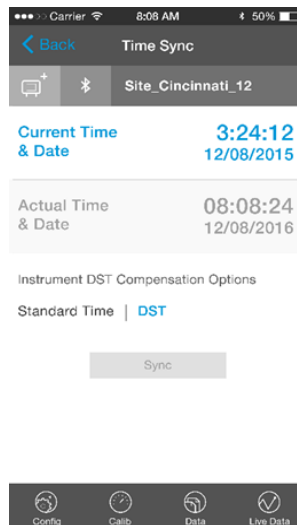

The instrument time syncs with the date and time of your mobile device.

## 5.12 Secure Sign On

Cloud Link 4G Modem can be accessed through the following interfaces

- Serial
- BLE
- Cellular
- IrDA (via EC350)

A valid user name and password are required for accessing the Cloud Link 4G Modem, and each device supports up-to 100 users.

### 5.12.1 Secure Sign On Over Bluetooth

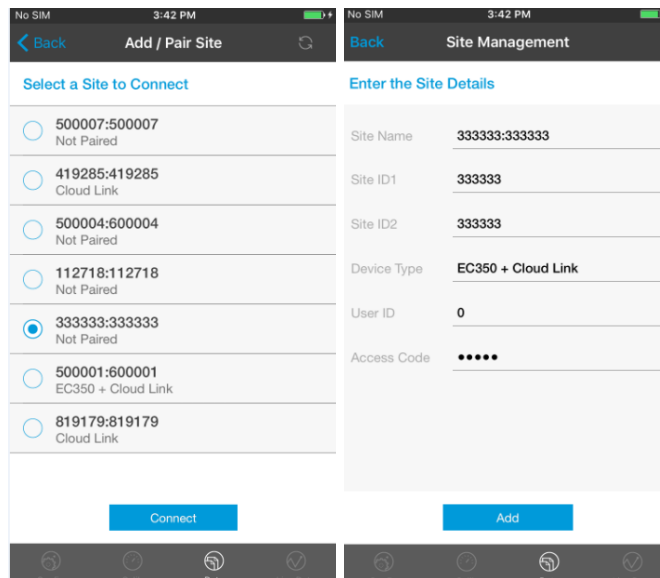

1. Connect to an existing site or add a new site

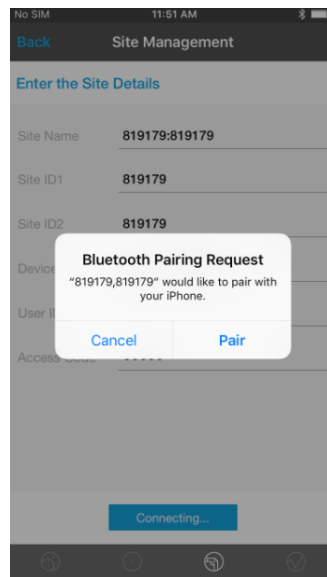

2. Pair the device with your mobile handset



## 5.12.2 White List

You may need to white list an IP address if you want to connect the the server remotely. White list feature is applicable only when the Cloud Link 4G Modem is in server mode to allow a configured client IP addresses to connect to device.

This feature can be enabled by

1. Selecting *Enable* option for White List Enable
2. Allowing client IP addresses in white-listing configuration group.

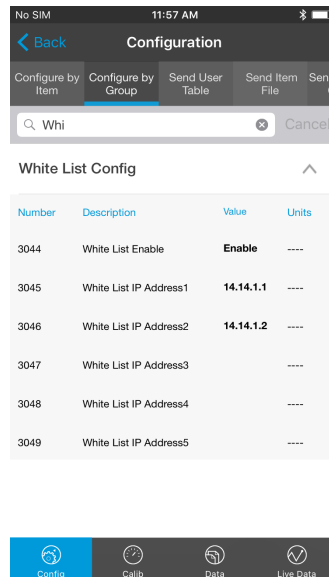

**Note:** Client IP addresses can either be PowerSpring or MasterLink PC's IP address.

## 5.13 Logs

### 5.13.1 Event Logs

Cloud Link 4G Modem supports event logging. The Event Log records activity is directly linked to and maintained within the instrument. Event Log activities include, Calibration Changes, Access Code Changes, Shutdown, Item Code Changes, AGA-8 Table, and Event Log Downloads.

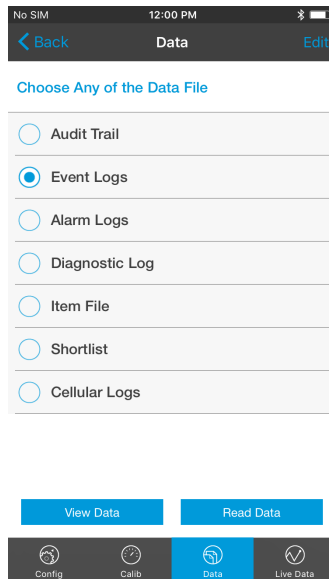

1. Tap Data, and select Event Logs

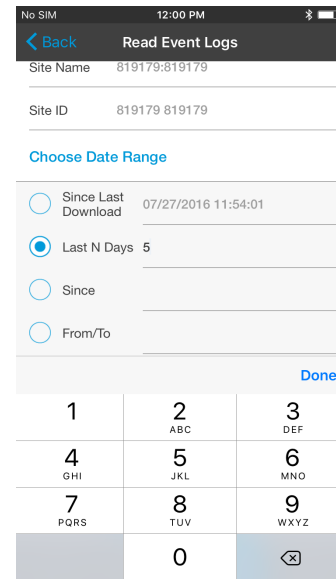

2. Select the Date Range

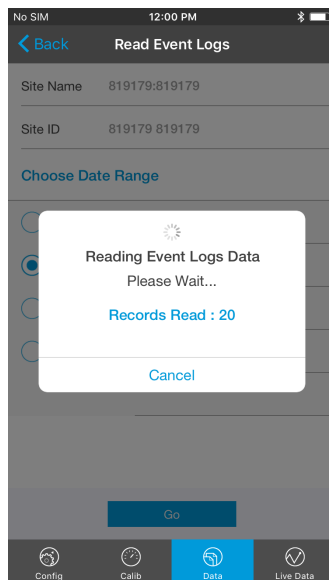

3. Wait for the logs to be retrieved

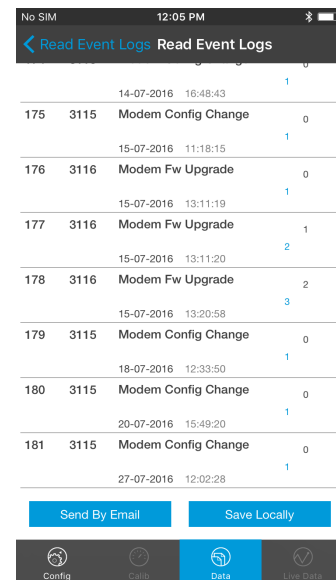

4. View or export event logs

List of events:

SL.NO	Events	ITEM Code
1	Configuration parameters changed	3115
2	OTA firmware upgrade event	3116
3	Password Change	3117
4	Host Contact IP Address changed	3110
5	Host Contact Port Number Changed	3111
6	log in fail event	3119

## 5.13.2 Diagnostic Logs

Cloud Link 4G Modem supports failure diagnostic logging.

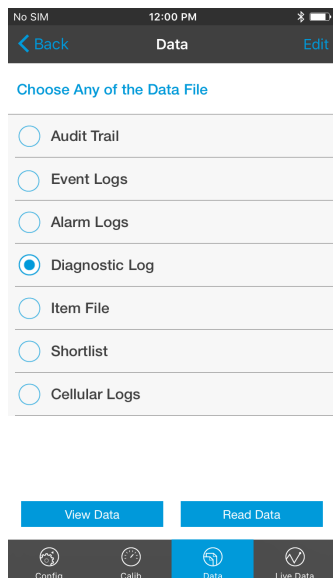

1. Tap **Data**, and select **Diagnostic Log**

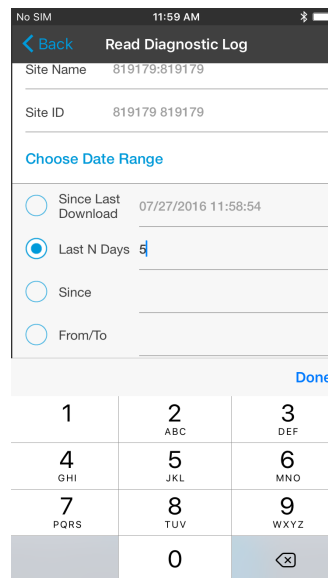

2. Select the **Date Range**

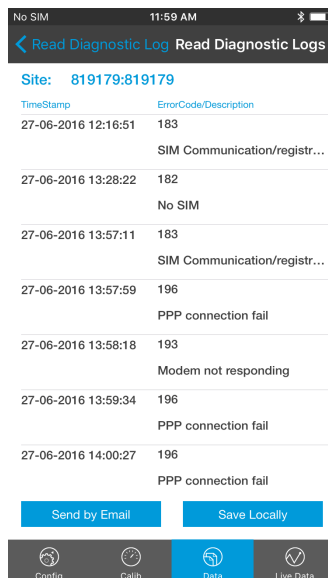

3. View or export diagnostic logs

### 5.13.3 Alarm Logs

The Read Alarm Log function reads alarm activity data from a field instrument and transfers it to the alarm file. An Alarm Log record is defined as any alarm activity, which includes new alarms as well as alarms that have been cleared.

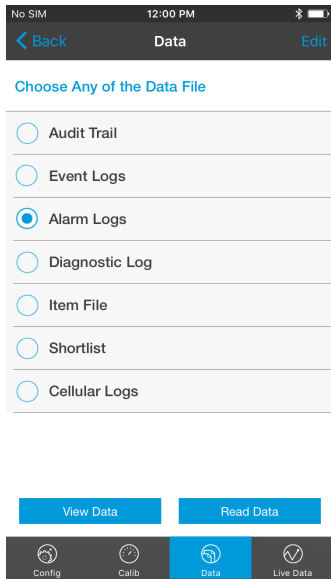

1. Tap **Data**, and select **Alarm Logs**

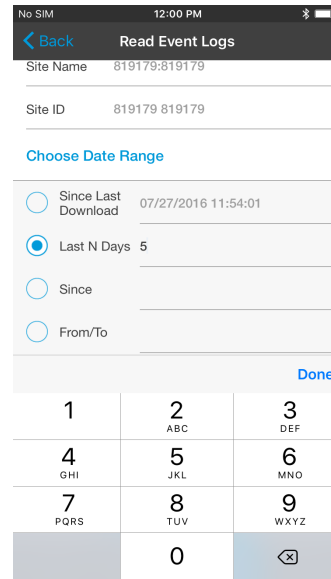

2. Select the **Date Range**

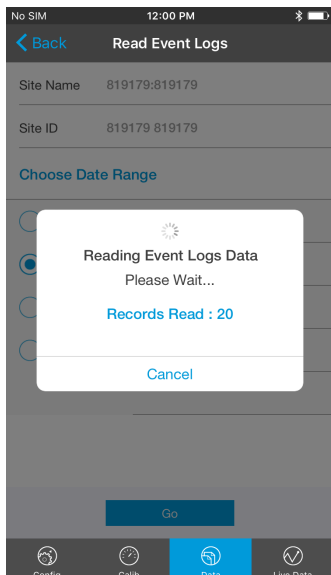

3. Wait for the logs to be retrieved

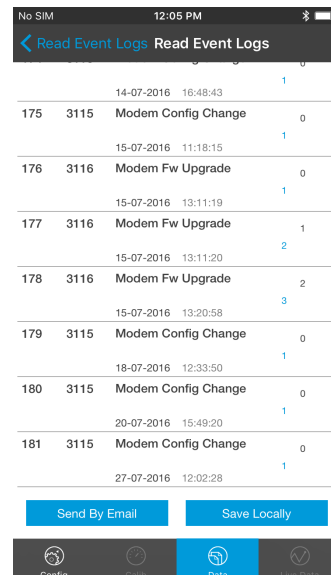

4. View or export Alarm logs

List of alarms with alarm type:

S.NO	Alarms	ITEM Code	Status Code	Alarm Type
1	Low Battery Alarm	3120	0 - Not Active 1-Active	ALARM_LOG_ALARM_SET, ALARM_LOG_ALARM_READ, ALARM_LOG_ALARM_CLEARED
2	Emergency call in alarm	3121	0 - Not Active 1-Active	ALARM_LOG_ALARM_SET, ALARM_LOG_ALARM_READ, ALARM_LOG_ALARM_CLEARED

### 5.13.4 Cellular Logs

Cloud Link 4G Modem supports Cellular logging. By default, the device shows the most recent 10 Cellular logs.

S.NO	Cellular Statistics	ITEM Code
1	Access Technology	3124
2	RSSI	3058
3	RSRP	3132
4	RSCP	3127
5	RSRQ	3128
6	Location ID / TAC	3126
7	Cell ID	3125
8	Physical Cell ID	3131
9	MCC	3129
10	MNC	3130
11	Last Call Duration	3134
12	Last Call Status	3135