

Flow Measurement

SITRANS FM (electromagnetic)

Flow sensors

MAG 3100 P

Overview



The SITRANS FM MAG 3100 P is designed to meet the most common specifications within chemical and process industries.

Benefits

- DN 15 to DN 300 (½" to 12")
- Included in Quick Ship Program (delivery time see PIA LCP)
- Most used flowmeter in the chemical and process industries with PTFE/PFA liner and Hastelloy electrodes
- Excellent chemical resistance
- Full scope of global approvals for hazardous areas:
 - ATEX, FM, CSA, IECEx
 - 24 V and 115/230 V Ex compact and remote
 - intrinsically safe ia analog output
- Comprehensive self-diagnostic for error indication and error logging
- Fully welded construction provides a ruggedness that suits the toughest applications and environments.
- Easy commissioning, the SENSORPROM unit automatically updates settings.
- MAG 6000 I full NAMUR compliance
 - compliant with NE 21, NE 32, NE 43, NE 53 and NE70

Application

The main applications of the SITRANS FM electromagnetic flow sensors can be found in the following fields:

- Chemical industry
- Process industry
- Pulp and paper
- Industrial waste water

Design

- Compact or remote mounting possible
- Easy "plug & play" field changeability of transmitter
- High temperature sensor for applications with temperatures up to 150 °C (302 °F)
- Meets EEC directives: PED, 2014/68/EU pressure directive for EN 1092-1 flanges
- Build-in length according to ISO 20456
- Onsite or factory upgrade to IP68/NEMA 6P of a standard sensor.

Mode of operation

The flow measuring principle is based on Faraday's law of electromagnetic induction according to which the sensor converts the flow into an electrical voltage proportional to the velocity of the flow.

Integration

The complete flowmeter consists of a flow sensor and an associated transmitter MAG 5000, 6000 and 6000 I.

The flexible communication concept USM II simplifies integration and update to a variety of fieldbus systems such as HART, FOUNDATION Fieldbus H1, DeviceNet, PROFIBUS DP and PA, Modbus RTU/RS 485.

Pressure-temperature curve to EN (DIN) flanges, material A 105 carbon steel

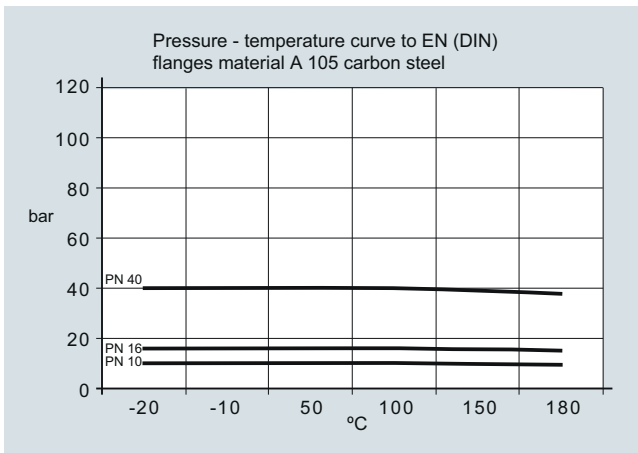

Pressure-temperature curve to ANSI B16.5 flanges

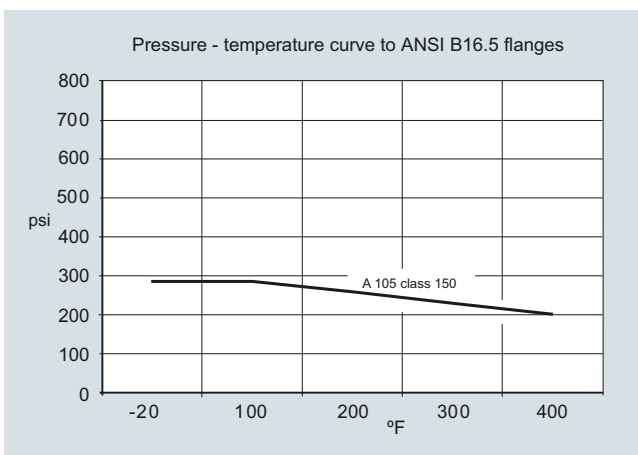

Note: The pressure-temperature curves only assist in the selection of a system. No responsibility is taken for the correctness of the information. For exact data please refer to the PED requirements. For further information on the PED standard and requirements, see Pressure Equipment Directive in Appendix (chapter 10).

Flow Measurement

SITRANS FM (electromagnetic)

Flow sensors

MAG 3100 P

Technical specifications

Product characteristic	Chemical and process industry-oriented (Included in Quick Ship Program)	Design	
Nominal size	<ul style="list-style-type: none"> • PTFE: DN 15 ... 300 (½" ... 12") • PFA: DN 15 ... 150 (½" ... 6") 	Weight	See dimensional drawings
Measuring principle	Electromagnetic induction	Flange and housing material	Carbon steel ASTM A 105, with corrosion resistant coating of category C4 according to ISO 12944-2
Excitation frequency (Mains supply: 50 Hz/60 Hz)	<ul style="list-style-type: none"> • DN 15 ... 65 (½" ... 2½"): 12.5 Hz/15 Hz • DN 80 ... 150 (3" ... 6"): 6.25 Hz/7.5 Hz • DN 200 ... 300 (8" ... 12"): 3.125 Hz/3.75 Hz 	Measuring pipe material	Stainless steel AISI 304/1.4301
Process connection		Electrode material	PTFE: Hastelloy C276/2.4819, Platinum, Tantalum PFA: Hastelloy C22/2.4602
Flanges	EN 1092-1, raised face ¹⁾ (EN 1092-1, DIN 2501 & BS 4504 have the same mating dimensions) <ul style="list-style-type: none"> • DN 15 ... 50 (½" ... 2"): PN 40 (580 psi) • DN 65 ... 300 (2½" ... 12"): PN 16 (232 psi) • DN 200 ... 300 (8" ... 12"): PN 10 (145 psi) ANSI B16.5 (~BS 1560), raised face <ul style="list-style-type: none"> • ½" ... 12": Class 150 (20 bar (290 psi)) 	Grounding electrode material	Optional in Hastelloy C22/2.602
Rated operation conditions		Terminal box (remote version only)	<ul style="list-style-type: none"> • Standard fibre glass reinforced polyamide • Option Stainless steel AISI 316/1.4436 • Ex sensor: Stainless steel AISI 316/1.4436
Ambient temperature (conditions also dependent on liner characteristics)	<ul style="list-style-type: none"> • Standard Sensor: -40 ... +100 °C (-40 ... +212 °F) • Ex sensor: -20 ... +60 °C (-4 ... +140 °F) • Compact with transmitter: <ul style="list-style-type: none"> - MAG 5000/6000: -20 ... +60 °C (-4 ... +140 °F) - MAG 6000 I: -20 ... +60 °C (-4 ... +140 °F) - MAG 6000 I Ex: -20 ... +60 °C (-4 ... +140 °F) 	Cable entries	<ul style="list-style-type: none"> • Remote installation 2 x M20 or 2 x ½" NPT • Compact installation <ul style="list-style-type: none"> - MAG 5000/MAG 6000: 4 x M20 or 4 x ½" NPT - MAG 6000 I: 2 x M25 or 2 x ½" NPT (for supply/output) - MAG 6000 I Ex de: 2 x M25 or 2 x ½" NPT (for supply/output)
Operating pressure [abs. bar] (maximum operating pressure decreases with increasing operating temperature and with stainless steel flanges)	<ul style="list-style-type: none"> • PTFE Teflon <ul style="list-style-type: none"> - DN 15 ... 300 (½" ... 12"): 0.3 ... 40 bar (4 ... 580 psi) • PFA <ul style="list-style-type: none"> - DN 15 ... 150 (½" ... 6"): Vacuum 0.02 ... 50 bar (0.29 ... 725 psi) 	Certificates and approvals	
Enclosure rating	IP67 to EN 60529/NEMA 4X/6, 1 mH ₂ O for 30 min Option: IP68 to EN 60529/NEMA 6P, 10 mH ₂ O cont. (not for Ex)	Calibration	<ul style="list-style-type: none"> • Default calibration: Zero-point, 2 x 25 % and 2 x 90 %
Pressure drop at 3 m/s	As straight pipe	Hazardous areas	<ul style="list-style-type: none"> • Ex-sensor in compact or remote version with MAG 6000 I Ex <ul style="list-style-type: none"> • ATEX, FM, CSA, IECEx, EAC Ex, NEPSI <ul style="list-style-type: none"> - Zone 1 Ex de ia IIC T6 Gb • ATEX, FM, CSA, IECEx <ul style="list-style-type: none"> - Zone 21 Ex tD A21 IP67 • FM <ul style="list-style-type: none"> - XP IS Class I Div. 1 Groups A, B, C, D²⁾ - DIP Class II+III Div. 1 Groups E, F, G²⁾ • FM <ul style="list-style-type: none"> - NI Class I Div. 2 Groups A, B, C, D - NI Class I Zone 2 Groups IIC
Test pressure	1.5 x PN (where applicable)	Pressure equipment	PED, CRN
Mechanical load (Vibration)	<ul style="list-style-type: none"> • 18 ... 1000 Hz random in x, y, z, directions for 2 hours according to EN 60068-2-36 • Sensor: 3.17 g RMS • Sensor with compact MAG 5000/6000 mounted transmitter: 3.17 g RMS • Sensor with compact MAG 6000 I/6000 I Ex mounted transmitter: 1.14 g RMS 	Others	<ul style="list-style-type: none"> • EAC (Russia, Belarus, Kazakhstan) • KCC (South Korea)
Temperature of medium	<ul style="list-style-type: none"> • PTFE -20 ... +130 °C (-4 ... +266 °F) • PFA -20 ... +150 °C (-4 ... +302 °F) 		
EMC	2014/30/EU		

¹⁾ DN ≤ 600 type 01 (SORF); DN > 600 type 11 (WNRF)

²⁾ In compact version only.

Technical specifications (continued)

Available Options for the SITRANS MAG 3100 P

The MAG 3100P is designed to meet the most common specifications within chemical and process industries. Therefore not all options are available. If you miss a few options please check out or product MAG 3100 which is covering many more options.

Available Options for Liner PTFE with Platinum electrodes

Diameter		Connection			
MAG 3100 P	Order code	EN 1092-1, PN 10	EN 1092-1, PN 16	EN 1092-1, PN 40	AISI B 16.5, class 150
DN 15, ½"	1V			•	
DN 25, 1"	2D			•	•
DN 40, 1 ½"	2R			•	
DN 50, 2"	2Y			•	•
DN 65, 2 ½"	3F				
DN 80, 3"	3M		•		
DN 100, 4"	3T		•		
DN 125, 5"	4B		•		
DN 150, 6"	4H		•		
DN 200, 8"	4P				
DN 250, 10"	4V				
DN 300, 12"	5D				

Available Options for Liner PTFE with Tantalum electrodes

Diameter		Connection			
MAG 3100 P	Order code	EN 1092-1, PN 10	EN 1092-1, PN 16	EN 1092-1, PN 40	AISI B 16.5, class 150
DN 15, ½"	1V			•	
DN 25, 1"	2D			•	•
DN 40, 1 ½"	2R			•	
DN 50, 2"	2Y			•	•
DN 65, 2 ½"	3F		•		
DN 80, 3"	3M		•		•
DN 100, 4"	3T		•		•
DN 125, 5"	4B				
DN 150, 6"	4H		•		
DN 200, 8"	4P		•		
DN 250, 10"	4V		•		
DN 300, 12"	5D				

Available Options for Liner PTFE with Hastelloy C electrodes incl. grounding electrodes

Diameter		Connection			
MAG 3100 P	Order code	EN 1092-1, PN 10	EN 1092-1, PN 16	EN 1092-1, PN 40	AISI B 16.5, class 150
DN 15, ½"	1V			•	
DN 25, 1"	2D			•	•
DN 40, 1 ½"	2R			•	
DN 50, 2"	2Y			•	•
DN 65, 2 ½"	3F		•		
DN 80, 3"	3M		•		•
DN 100, 4"	3T		•		•
DN 125, 5"	4B				
DN 150, 6"	4H		•		•
DN 200, 8"	4P				•
DN 250, 10"	4V				•
DN 300, 12"	5D				

Flow Measurement

SITRANS FM (electromagnetic)

Flow sensors

MAG 3100 P

Selection and ordering data

Article No.

Order code

Sensor SITRANS FM MAG 3100 P (Short delivery time)

7ME6340-

Click on the Article No. for the online configuration in the PIA Life Cycle Portal.

Diameter

DN 15 (1/2")

1 V

DN 25 (1")

2 D

DN 40 (1 1/2")

2 R

DN 50 (2")

2 Y

DN 65 (2 1/2")

3 F

DN 80 (3")

3 M

DN 100 (4")

3 T

DN 125 (5")

4 B

DN 150 (6")

4 H

DN 200 (8")

4 P

DN 250 (10")

4 V

DN 300 (12")

5 D

Flange norm and pressure rating

EN 1092-1

PN 10 (DN 200 ... 300 (8" ... 12"))

B

PN 16 (DN 65 ... 300 (2 1/2" ... 12"))

C

PN 40 (DN 15 ... 50 (1/2" ... 2"))

F

ANSI B16.5

Class 150 (1/2" ... 12")

J

Flange material

Carbon steel flanges ASTM A 105

1

Liner material

PTFE (150 °C (302 °F))

3

PFA (150 °C (302 °F)) (DN 15 ... 150 (1/2" ... 6"))

7

Electrode material

Hastelloy C

2

Platinum

3

Tantalum

5

Hastelloy C incl. grounding electrodes

6

Transmitter

Standard sensor for remote transmitter (Order transmitter separately)

A

Ex sensor for remote transmitter (Order transmitter separately)

B

MAG 6000 I, Aluminum, 18 ... 90 V DC, 115 ... 230 V AC

C

MAG 6000 I, Aluminum, 18 ... 30 V DC, Ex

D

MAG 6000 I, Aluminum, 115 ... 230 V AC, Ex

E

MAG 6000, Polyamide, 11 ... 30 V DC/11 ... 24 V AC

H

MAG 6000, Polyamide, 115 ... 230 V AC

J

MAG 5000, Polyamide, 11 ... 30 V DC/11 ... 24 V AC

K

MAG 5000, Polyamide, 115 ... 230 V AC

L

Communication

No communication, add-on possible

A

HART

B

PROFIBUS PA Profile 3 (only MAG 6000/MAG 6000 I)

F

PROFIBUS DP Profile 3 (not for Ex) (only MAG 6000/MAG 6000 I)

G

Modbus RTU/RS 485 (not for Ex) (only MAG 6000/MAG 6000 I)

E

FOUNDATION Fieldbus H1 (only MAG 6000/6000 I)

J

Cable glands/terminal box

Metric: Polyamide terminal box or MAG 6000 I compact

1

1/2" NPT: Polyamide terminal box or MAG 6000 I compact

2

Metric: Stainless steel terminal box

3

1/2" NPT: Stainless steel terminal box

4

Additional information

Please add "-Z" to Article No. and specify Order code(s) and plain text.

Certificates

- Factory certificate according to EN 10204-2.2
- Factory certificate according to EN 10204-2.1

C14

C15

Terminal blocks

- Factory mounted terminal blocks

N02

Country specific label

- CRN (Canadian Registration Number)

H25

Tag name plate, stainless steel (specify in plain text)

Y17

Tag name plate, plastic (self adhesive)

Y18

Customer-specific transmitter setting

Y20

Factory mounted sensor cables

- Sensor cables wired (specify Article No. for sensor cables and order cables separately)
- Sensor cables wired and IP68 sealing (specify Article No. for sensor cables and order cables separately)

Y40

Y41

Additional calibrations

- Matched-pair calibration
- Accredited matched-pair calibration acc. to ISO/IEC 17025: 2005
- Customer-specified calibration up to 10 points
- Customer-witnessed calibration

On request¹⁾On request¹⁾On request¹⁾On request¹⁾

¹⁾ Product Variation Request (PVR).

Operating instructions for SITRANS FM MAG 3100 P

Description

Article No.

- English
- German

A5E03005599

A5E03086288

All literature is available to download for free, in a range of languages, at

<http://www.siemens.com/processinstrumentation/documentation>

Accessories

Description

Article No.

Potting kit for IP68/NEMA 6P sealing of sensor junction box

FDK-085U0220



Please use online Product selector to get latest updates.

Product selector link:

<http://www.pia-selector.automation.siemens.com>

Selection and ordering data (continued)

Accessories for MAG 3100 P sensor

Grounding and protection ring - Type E (Stainless steel)

- Material: AISI 316
- For liner PTFE
- 1 pc. incl. straps and screws

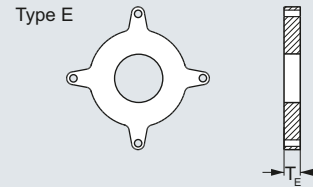

Size	Nominal pressure			Size	ANSI ¹⁾
DN	PN 10	PN 16	PN 40	Inch	Class 150
	Article No.	Article No.	Article No.		Article No.
DN 15			FDK:083N8365	½"	FDK:083N8365
DN 25			FDK:083N8271	1"	FDK:083N8272
DN 40			FDK:083N8278	1½"	FDK:083N8279
DN 50			FDK:083N8282	2"	FDK:083N8283
DN 65		FDK:083N8285		2½"	FDK:083N8287
DN 80		FDK:083N8289		3"	FDK:083N8291
DN 100		FDK:083N8117		4"	FDK:083N8118
DN 125		FDK:083N8121		5"	FDK:083N8122
DN 150		FDK:083N8125		6"	FDK:083N8126
DN 200	FDK:083N8130	FDK:083N8130		8"	FDK:083N8370
DN 250	FDK:083N8136	FDK:083N8137		10"	FDK:083N8140
DN 300	FDK:083N8144	FDK:083N8145		12"	FDK:083N8148

For use as protection ring order 2 pcs.

For use as grounding ring order 1 pc.

Grounding and protection ring - Type E (Hastelloy)

- Material: Hastelloy C276
- For liner PTFE
- 1 pc. incl. straps and screws

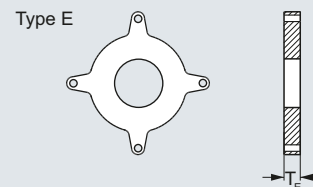

Size	Nominal pressure		Size	ANSI ¹⁾
DN	PN 16	PN 40	Inch	Class 150
	Article No.	Article No.		Article No.
DN 15		FDK:083N8487	½"	FDK:083N8487
DN 25		FDK:083N8488	1"	FDK:083N8489
DN 40		FDK:083N8490	1½"	FDK:083N8491
DN 50		FDK:083N8492	2"	FDK:083N8493
DN 65	FDK:083N8495		2½"	FDK:083N8497
DN 80	FDK:083N8499		3"	FDK:083N8501
DN 100	FDK:083N8504		4"	FDK:083N8506

¹⁾ For dimensions of MAG 3100 P see Dimensional drawings.

Flow Measurement

SITRANS FM (electromagnetic)

Flow sensors

MAG 3100 P**Selection and ordering data** (continued)**Grounding ring - Type Flat ring (Stainless steel)**

- Material: AISI 316
- For liner PTFE and PFA
- 1 pc. incl. straps and screws

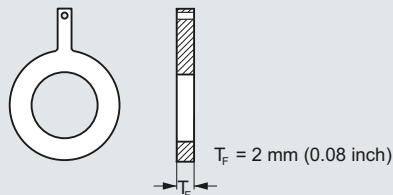

Size DN	Nominale pressure			Size Inch	ANSI ¹⁾ Class 150 Article No.
	PN 10 Article No.	PN 16 Article No.	PN 40 Article No.		
DN 15			A5E01191968	½"	A5E01191969
DN 25			A5E01150880	1"	A5E01150022
DN 40			A5E01191952	1½"	A5E01191961
DN 50			A5E01150918	2"	A5E01151121
DN 65		A5E01191940		2½"	A5E01191962
DN 80		A5E01152876		3"	A5E01152910
DN 100		A5E01158875		4"	A5E01159146
DN 125		A5E01191941		5"	A5E01191963
DN 150		A5E01191943		6"	A5E01191964
DN 200	A5E01191951	A5E01191944		8"	A5E01191965
DN 250	A5E01191950	A5E01191946		10"	A5E01191966
DN 300	A5E01191949	A5E01191947		12"	A5E01191967

¹⁾ For dimensions of MAG 3100 P see Dimensional drawings.

Grounding ring - Type Flat ring (Hastelloy)

- Material: Hastelloy C276
- For liner PTFE and PFA
- 1 pc. incl. straps and screws

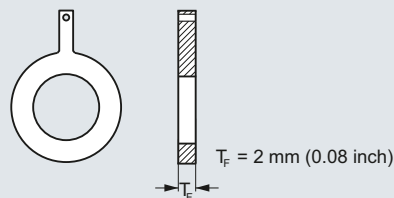

Size DN	Nominale pressure			Size Inch	ANSI ¹⁾ Class 150 Article No.
	PN 10 Article No.	PN 16 Article No.	PN 40 Article No.		
DN 15			A5E01191981	½"	A5E01191989
DN 25			A5E01150882	1"	A5E01150028
DN 40			A5E01191982	1½"	A5E01191990
DN 50			A5E01150922	2"	A5E01151124
DN 65		A5E01191971		2½"	A5E01191991
DN 80		A5E01152889		3"	A5E01152913
DN 100		A5E01158886		4"	A5E01159150
DN 125		A5E01191973		5"	A5E01191992
DN 150		A5E01191974		6"	A5E01191993
DN 200	A5E01191978	A5E01191975		8"	A5E01191994
DN 250	A5E01191979	A5E01191976		10"	A5E01191995
DN 300	A5E01191980	A5E01191977		12"	A5E01191996

¹⁾ For dimensions of MAG 3100 P see Dimensional drawings.

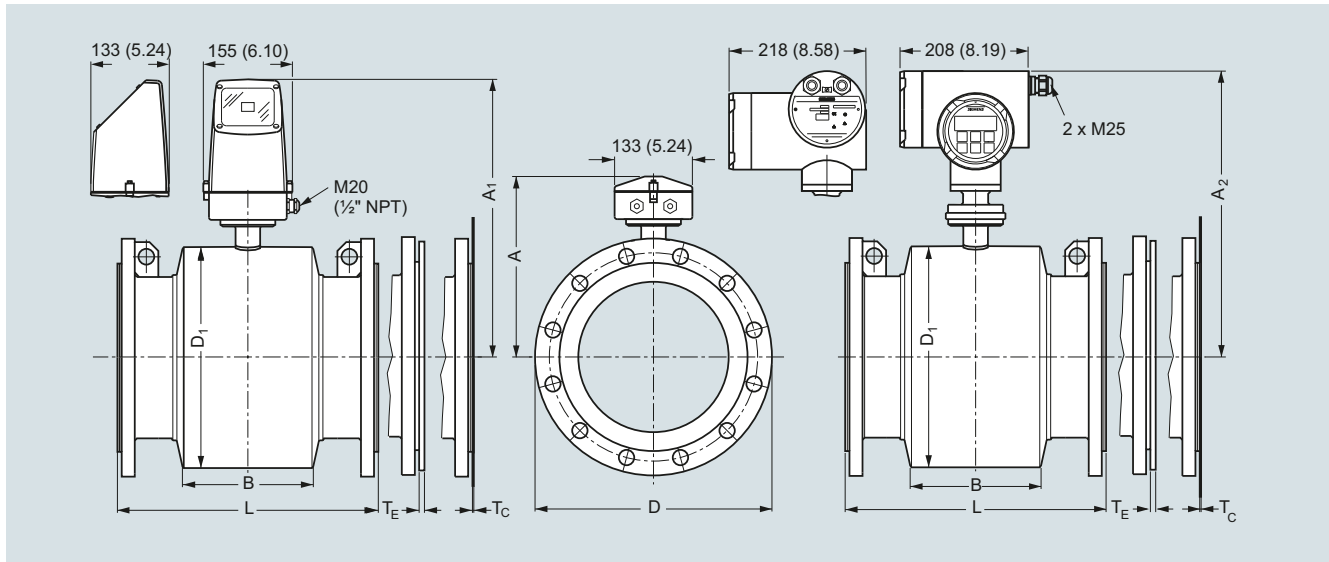
Dimensional drawings
MAG 3100 P sensor with compact or remote transmitter

Dimensions in mm (inch)

Metric

DN	A ¹⁾	A ₁	A ₂	B	D1	L ²⁾			ANSI 16.5 Class 150	T _E ³⁾	T _F ³⁾	Weight ⁴⁾
						EN 1092-1-201 PN 10	PN 16	PN 40				
[mm]	[mm]	[mm]	[mm]	[mm]	[mm]	[mm]	[mm]	[mm]	[mm]	[mm]	[kg]	
15	187	341	338	59	104	-	-	200	200	6	2	4
25	187	341	338	59	104	-	-	200	200	6	2	5
40	197	351	348	82	124	-	-	200	200	6	2	8
50	205	359	356	72	139	-	-	200	200	6	2	9
65	212	369	366	72	154	-	200/-	-	200	6	2	11
80	222	376	373	72	174	-	200/-	-	272 ⁵⁾	6	2	12
100	242	396	393	85	214	-	250/-	-	250	6	2	16
125	255	409	406	85	239	-	250/-	-	250	6	2	19
150	276	430	427	85	282	-	300/-	-	300	6	2	27
200	304	458	455	137	338	350	350/-	-	350	8	2	40
250	332	486	483	157	393	450	450/-	-	450	8	2	60
300	357	511	508	157	444	500	500/-	-	500	8	2	80

1) 14.5 mm shorter with stainless steel terminal box (Ex and high temperature version)

2) When grounding rings are used, the thickness of the grounding ring must be added to the built-in length.

 3) T_E = Grounding ring Type E, T_F = Grounding ring Type Flat ring

4) Weights are approx. (for PN 16) without transmitter

5) Not according to ISO 20456

- not available

D = Outside diameter of flange, see flange tables

Flow Measurement

SITRANS FM (electromagnetic)

Flow sensors

MAG 3100 P**Dimensional drawings** (continued)

Imperial

DN	A ¹⁾	A ₁	A ₂	B	D1	L ²⁾				T _E ³⁾	T _F ³⁾	Weight ⁴⁾
						EN 1092-1-201		ANSI 16.5				
[inch]	[inch]	[inch]	[inch]	[inch]	[inch]	PN 10	PN 16	PN 40	Class 150	[inch]	[inch]	[lbs]
½	7.36	13.4	13.34	2.32	4.09	-	-	7.87	7.87	0.24	0.08	9
1	7.36	13.4	13.34	2.32	4.09	-	-	7.87	7.87	0.24	0.08	11
1½	7.76	13.8	13.74	3.23	4.88	-	-	7.87	7.87	0.24	0.08	17
2	8.07	14.1	14.04	2.83	5.47	-	-	7.87	7.87	0.24	0.08	20
2½	8.35	14.4	14.34	2.83	6.06	-	7.87/-	-	7.87	0.24	0.08	24
3	8.74	14.8	14.74	2.83	6.85	-	7.87/-	-	10.71 ⁵⁾	0.24	0.08	26
4	9.53	15.6	15.54	3.35	8.43	-	9.84/-	-	9.84	0.24	0.08	35
5	10.04	16.1	16.04	3.35	9.41	-	9.84/-	-	9.84	0.24	0.08	42
6	10.87	16.9	16.84	3.35	11.10	-	11.81/-	-	11.81	0.24	0.08	60
8	11.97	18.0	17.94	5.39	13.31	13.78	13.78/-	-	13.78	0.31	0.08	88
10	13.07	19.1	19.04	6.18	15.47	17.72	17.72/-	-	17.72	0.31	0.08	132
12	14.05	20.1	20.04	6.18	17.48	19.69	19.69/-	-	19.69	0.31	0.08	176

1) 0.571 inch shorter with stainless steel terminal box (Ex and high temperature version)

2) When grounding rings are used, the thickness of the grounding ring must be added to the built-in length.

3) T_E = Grounding ring Type E, T_F = Grounding ring Type Flat ring

4) Weights are for ANSI 150 without transmitter.

5) Not according to ISO 20456

D = Outside diameter of flange, see flange tables