

Drawings

MODEL 735102 AQ2212 Frame Controller

AQ2212

Unit : mm
(approx. inch)

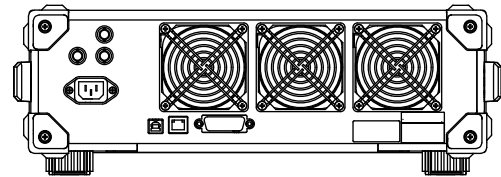
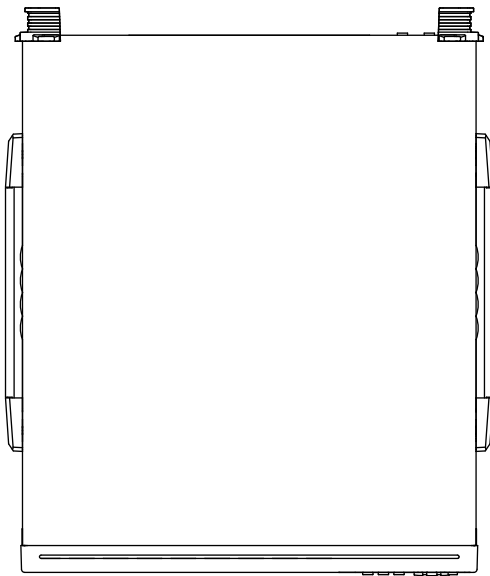

REAR VIEW

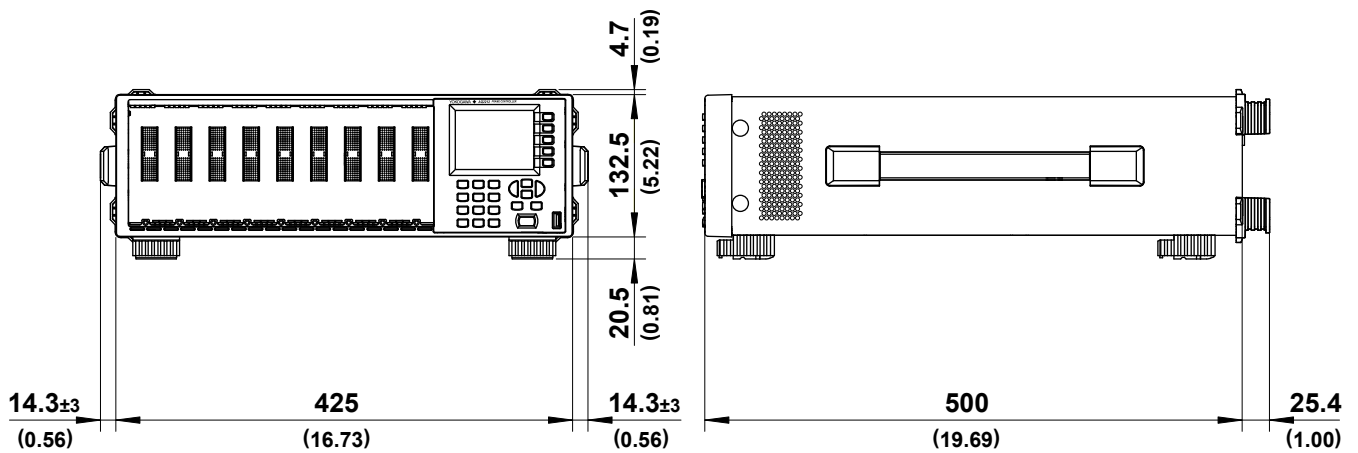

If not specified, the tolerance is ±3%. However, in cases of less than 10 mm, the tolerance is ±0.3 mm.